



RIGOL

DP2000 Series

Programmable
Linear DC Power Supply

User Guide
Apr.2022

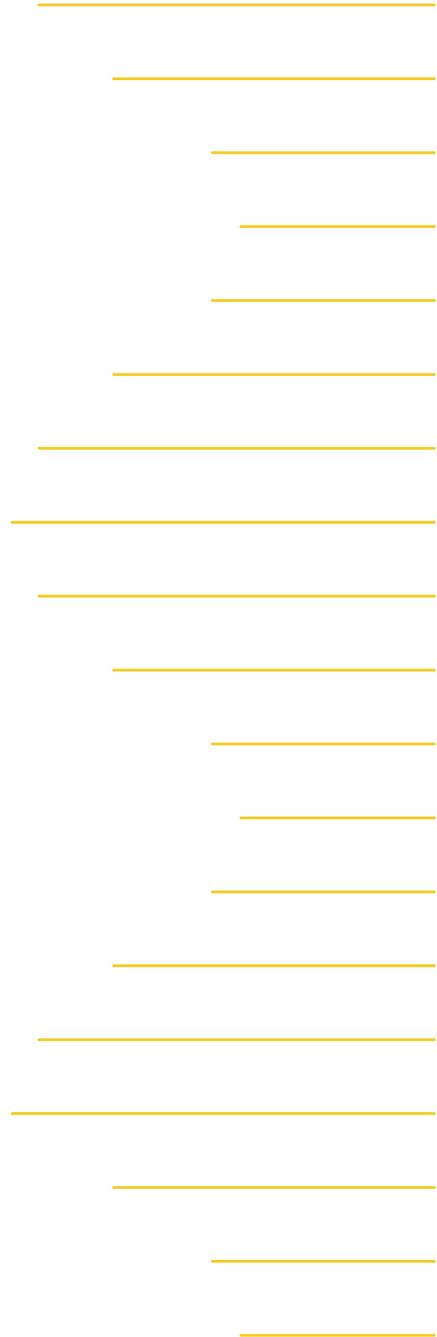

Guaranty and Declaration

Copyright

© 2022 RIGOL TECHNOLOGIES CO., LTD. All Rights Reserved.

Trademark Information

RIGOL® is the trademark of RIGOL TECHNOLOGIES CO., LTD.

Notices

- RIGOL products are covered by P.R.C. and foreign patents, issued and pending.
- RIGOL reserves the right to modify or change parts of or all the specifications and pricing policies at the company's sole decision.
- Information in this publication replaces all previously released materials.
- Information in this publication is subject to change without notice.
- RIGOL shall not be liable for either incidental or consequential losses in connection with the furnishing, use, or performance of this manual, as well as any information contained.
- Any part of this document is forbidden to be copied, photocopied, or rearranged without prior written approval of RIGOL.

Product Certification

RIGOL guarantees that this product conforms to the national and industrial standards in China as well as the ISO9001:2015 standard and the ISO14001:2015 standard. Other international standard conformance certifications are in progress.

Contact Us

If you have any problem or requirement when using our products or this manual, please contact RIGOL.

E-mail: service@rigol.com

Website: <http://www.rigol.com>

Section	Description	Page
	List of Figures.....	IV
	List of Tables.....	VI
1	Safety Requirement.....	1
1.1	General Safety Summary.....	1
1.2	Safety Notices and Symbols.....	3
1.3	Measurement Category.....	3
1.4	Ventilation Requirement.....	4
1.5	Working Environment.....	4
1.6	Care and Cleaning.....	6
1.7	Environmental Considerations.....	6
2	Product Overview.....	8
3	Document Overview.....	9
4	Quick Start.....	11
4.1	General Inspection.....	11
4.2	Appearance and Dimensions.....	12
4.3	Front Panel.....	12
4.4	Rear Panel.....	16
4.5	User Interface.....	17
4.6	Connecting to Power.....	19
4.7	Power-on Inspection.....	21
4.8	Connecting the Outputs.....	21
4.9	Replacing the Fuse.....	22
4.10	Using the Built-in Help System.....	23
5	Using the Protection Function.....	25
6	Constant Voltage Output.....	27
7	Constant Current Output.....	30
8	Series/Parallel Connections.....	31
8.1	Series Connections.....	31
8.2	Parallel Connections.....	34
9	Arb Function.....	37
9.1	Setting Arb Properties.....	38
9.2	Arb Editor.....	40
9.2.1	Inserting a Single Point.....	41

9.2.2	Editing Waveform Templates.....	41
9.2.3	Delete.....	47
9.3	Import and Export.....	47
9.4	Enabling the Arb Output.....	48
10	Analyzer.....	49
10.1	Common Analysis.....	49
10.1.1	Selecting Analysis Object.....	50
10.1.2	Selecting Statistical Method.....	51
10.2	Pulse Current Analysis.....	52
10.3	Data Logging.....	53
10.4	Print Screen.....	54
10.5	Label Control.....	54
11	Trigger.....	55
11.1	Trigger Input.....	56
11.2	Trigger Output.....	57
12	Store and Recall.....	59
12.1	Select.....	60
12.2	Save.....	60
12.3	Read.....	61
12.4	Delete.....	61
12.5	Copy and Paste.....	62
13	Utility.....	63
13.1	System Settings.....	63
13.1.1	Instrument Settings.....	64
13.1.2	Display Options.....	67
13.1.3	Sense Settings.....	67
13.2	Output Settings.....	69
13.2.1	Track Mode.....	69
13.2.2	Safe Mode.....	70
13.2.3	Sampling Mode.....	70
13.2.4	Output Connection.....	71
13.2.5	Output Off Mode.....	71
13.2.6	Current Sampling Rate.....	72
13.3	Interface Settings.....	72
13.3.1	LXI Status.....	72
13.3.2	LXI Setting.....	74
13.3.3	RS232 Setting.....	76

13.3.4	USB Configuration.....	78
13.3.5	GPIB Configuration.....	79
13.4	Option Settings.....	80
14	Locking/Unlocking the Front Panel.....	82
15	Remote Control.....	84
15.1	Remote Control via USB.....	85
15.2	Remote Control via LAN.....	85
15.3	Remote Control via GPIB (Optional).....	86
15.4	Remote Control via RS232.....	87
16	Troubleshooting.....	90
17	Specifications.....	92
18	Appendix.....	97
18.1	Appendix A: Accessories and Options.....	97
18.2	Appendix B: Warranty.....	97

List of Figures

Figure 4.1 Front View	12
Figure 4.2 Side View	12
Figure 4.3 DP2000 Front Panel	13
Figure 4.4 DP2000 Output Terminals	15
Figure 4.5 DP2000 Rear Panel	16
Figure 4.6 User Interface	18
Figure 4.7 Help Interface	23
Figure 5.1 CH1 Output Settings Interface	25
Figure 8.1 Series Output Interface	32
Figure 8.2 External Series Circuit	33
Figure 8.3 Parallel Output Interface	34
Figure 8.4 External Parallel Circuit	36
Figure 9.1 Arb Main Interface	37
Figure 9.2 Arb Settings Interface	38
Figure 9.3 Arb Editor Interface	40
Figure 9.4 Template Editing Menu	41
Figure 9.5 Arb Output Interface	48
Figure 10.1 Analyzer Main Interface	49
Figure 10.2 Common Analysis Setting Interface	50
Figure 10.3 Analysis Object Setting Menu	50
Figure 10.4 Pulse Current Analysis Setting Interface	52
Figure 10.5 Pulse Current Analysis Interface	53
Figure 10.6 Log Setting Interface	53
Figure 11.1 Digital Port Connections	55
Figure 11.2 Trigger Setting Interface	56
Figure 11.3 Trigger Input Setting Interface	56
Figure 11.4 Trigger Output Setting Interface	58

Figure 12.1 Disk Interface	59
Figure 13.1 Utility Interface	63
Figure 13.2 Instrument Settings Interface	64
Figure 13.3 Display Options Interface	67
Figure 13.4 Rear Panel Connections	68
Figure 13.5 Sense Settings Interface	68
Figure 13.6 Output Settings Interface	69
Figure 13.7 Interface Settings	72
Figure 13.8 LXI Status Interface	73
Figure 13.9 LXI Settings Menu	74
Figure 13.10 RS232 Interface	77
Figure 13.11 RS232 Configuration Interface	78
Figure 13.12 USB Configuration Interface	79
Figure 13.13 GPIB Configuration Interface	79
Figure 13.14 Option Settings Interface	80
Figure 15.1 Search for the Available Device	87
Figure 15.2 Confirm the Available Device	87

List of Tables

Table 4.1 DP2000 Rear Panel Description	16
Table 4.2 User Interface Description	18
Table 4.3 AC input power specifications (including AC selector setting)	19
Table 4.4 Fuse Rating	22
Table 9.1 Arb Parameters (Template)	45
Table 13.1 Factory Default Values	65
Table 13.2 RS232 Pin Definition	77

1 Safety Requirement

1.1 General Safety Summary

Please review the following safety precautions carefully before putting the instrument into operation so as to avoid any personal injury or damage to the instrument and any product connected to it. To prevent potential hazards, please follow the instructions specified in this manual to use the instrument properly.

- **Use Proper Power Cord.**

Only the exclusive power cord designed for the instrument and authorized for use within the destination country could be used.

- **Ground the Instrument.**

The instrument is grounded through the Protective Earth lead of the power cord. To avoid electric shock, it is essential to connect the earth terminal of the power cord to the Protective Earth terminal before connecting any inputs or outputs.

- **Observe All Terminal Ratings.**

To avoid fire or shock hazard, observe all ratings and markers on the instrument and check your manual for more information about ratings before connecting the instrument.

- **Use Proper Overvoltage Protection.**

Ensure that no overvoltage (such as that caused by a bolt of lightning) can reach the product. Otherwise, the operator might be exposed to the danger of an electric shock.

- **Do Not Operate Without Covers.**

Do not operate the instrument with covers or panels removed.

- **Do Not Insert Objects Into the Air Outlet.**

Do not insert objects into the air outlet, as doing so may cause damage to the instrument.

- **Use the Proper Fuse.**

Please use the specified fuses.

- **Avoid circuit or wire exposure.**

Do not touch exposed junctions and components when the instrument is powered on.

- **Do Not Operate With Suspected Failures.**

If you suspect damage occurs to the instrument, have it inspected by RIGOL authorized personnel before further operations. Any maintenance, adjustment or

replacement especially to circuits or accessories must be performed by RIGOL authorized personnel.

- **Keep Well Ventilation.**

Inadequate ventilation may cause an increase of temperature in the instrument, which would cause damage to the instrument. So please keep the instrument well ventilated and inspect the air outlet and the fan regularly.

- **Do Not Operate in Wet Conditions.**

To avoid short circuit inside the instrument or electric shock, never operate the instrument in a humid environment.

- **Do Not Operate in an Explosive Atmosphere.**

To avoid personal injuries or damage to the instrument, never operate the instrument in an explosive atmosphere.

- **Keep Instrument Surfaces Clean and Dry.**

To avoid dust or moisture from affecting the performance of the instrument, keep the surfaces of the instrument clean and dry.

- **Prevent Electrostatic Impact.**

Operate the instrument in an electrostatic discharge protective environment to avoid damage induced by static discharges. Always ground both the internal and external conductors of cables to release static before making connections.

- **Use the Battery Properly.**

Do not expose the battery (if available) to high temperature or fire. Keep it out of the reach of children. Improper change of a battery (lithium battery) may cause an explosion. Use the RIGOL specified battery only.

- **Handle with Caution.**

Please handle with care during transportation to avoid damage to keys, knobs, interfaces, and other parts on the panels.

- **Do not use this instrument to provide power for the active load.**

The backflow current may cause the power control loop to be out of control, which could further damage the devices that receives the power supply from this instrument. Therefore, this instrument is only allowed to provide power for the pure load that does not have the current output function.



WARNING

Equipment meeting Class A requirements may not offer adequate protection to broadcast services within residential environment.

1.2 Safety Notices and Symbols

Safety Notices in this Manual:



WARNING

Indicates a potentially hazardous situation or practice which, if not avoided, will result in serious injury or death.



CAUTION

Indicates a potentially hazardous situation or practice which, if not avoided, could result in damage to the product or loss of important data.

Safety Symbols on the Product:

- **DANGER**
It calls attention to an operation, if not correctly performed, could result in injury or hazard immediately.
- **WARNING**
It calls attention to an operation, if not correctly performed, could result in potential injury or hazard.
- **CAUTION**
It calls attention to an operation, if not correctly performed, could result in damage to the product or other devices connected to the product.

Safety Symbols on the Product:



Hazardous Voltage



Safety Warning



Protective Earth Terminal

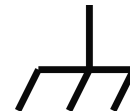

Chassis Ground



Test Ground

1.3 Measurement Category

Measurement Category

This instrument can make measurements in Measurement Category I.



WARNING

This instrument can only be used for measurements within its specified measurement categories.

Measurement Category Definitions

- **Measurement category I** is for measurements performed on circuits not directly connected to MAINS. Examples are measurements on circuits not derived from MAINS, and specially protected (internal) MAINS derived circuits. In the latter case, transient stresses are variable. Thus, you must know the transient withstand capability of the equipment.
- **Measurement category II** is for measurements performed on circuits directly connected to low voltage installation. Examples are measurements on household appliances, portable tools and similar equipment.
- **Measurement category III** is for measurements performed in the building installation. Examples are measurements on distribution boards, circuit-breakers, wiring (including cables, bus-bars, junction boxes, switches and socket-outlets) in the fixed installation, and equipment for industrial use and some other equipment. For example, stationary motors with permanent connection to a fixed installation.
- **Measurement category IV** is for measurements performed at the source of a low-voltage installation. Examples are electricity meters and measurements on primary overcurrent protection devices and ripple control units.

1.4 Ventilation Requirement

This instrument uses a fan to force cooling. Please make sure that the air inlet and outlet areas are free from obstructions and have free air. When using the instrument in a bench-top or rack setting, provide at least 10 cm clearance beside, above and behind the instrument for adequate ventilation.



CAUTION

Inadequate ventilation may cause an increase of temperature in the instrument, which would cause damage to the instrument. So please keep the instrument well ventilated and inspect the air outlet and the fan regularly.

1.5 Working Environment

Temperature

Operating: 0°C to +40°C

Non-operating: -40°C to +60°C

Humidity

- **Operating:**
Below +30°C: ≤90% RH (without condensation)

+30°C to +40°C: ≤75% RH (without condensation)

- **Non-operating:**

Below +65°C: ≤90%RH (without condensation)



WARNING

To avoid short circuit inside the instrument or electric shock, never operate the instrument in a humid environment.

Altitude

- **Operating:** below 3 km
- **Non-operating:** below 15 km

Protection Level Against Electric Shock

ESD ±8kV

Installation (Overvoltage) Category

This product is powered by mains conforming to installation (overvoltage) category II.



WARNING

Ensure that no overvoltage (such as that caused by a bolt of lightning) can reach the product. Otherwise, the operator might be exposed to the danger of an electric shock.

Installation (Overvoltage) Category Definitions

Installation (overvoltage) category I refers to signal level which is applicable to equipment measurement terminals connected to the source circuit. Among these terminals, precautions are done to limit the transient voltage to a low level.

Installation (overvoltage) category II refers to the local power distribution level which is applicable to equipment connected to the AC line (AC power).

Pollution Degree

Pollution Degree 2

Pollution Degree Definition

- **Pollution Degree 1:** No pollution or only dry, nonconductive pollution occurs. The pollution has no effect. For example, a clean room or air-conditioned office environment.
- **Pollution Degree 2:** Normally only nonconductive pollution occurs. Temporary conductivity caused by condensation is to be expected. For example, indoor environment.
- **Pollution Degree 3:** Conductive pollution or dry nonconductive pollution that becomes conductive due to condensation occurs. To be found in industrial

environment or construction sites (harsh environments). For example, sheltered outdoor environment.

- **Pollution Degree 4:** The pollution generates persistent conductivity caused by conductive dust, rain, or snow. For example, outdoor areas.

Safety Class

Class 1–Grounded Product

1.6 Care and Cleaning

Care

Do not store or leave the instrument where it may be exposed to direct sunlight for long periods of time.

Cleaning

Clean the instrument regularly according to its operating conditions.

1. Disconnect the instrument from all power sources.
2. Clean the external surfaces of the instrument with a soft cloth dampened with mild detergent or water. Avoid having any water or other objects into the chassis via the heat dissipation hole. When cleaning the LCD, take care to avoid scarifying it.



CAUTION

To avoid damage to the instrument, do not expose it to caustic liquids.



WARNING

To avoid short-circuit resulting from moisture or personal injuries, ensure that the instrument is completely dry before connecting it to the power supply.

1.7 Environmental Considerations

The following symbol indicates that this product complies with the WEEE Directive 2002/96/EC.



The equipment may contain substances that could be harmful to the environment or human health. To avoid the release of such substances into the environment and avoid harm to human health, we recommend you to recycle this product appropriately to ensure that most materials are reused or recycled properly. Please contact your local authorities for disposal or recycling information.

You can click on the following link <https://int.rigol.com/services/services/declaration> to download the latest version of the RoHS&WEEE certification file.

2 Product Overview

Product Features

- DP2031: 32 V/3 A || 32 V/3 A || 6 V/5 A (10 A)^[1]
- 3 electrically isolated independent channels with a maximum total power of 222 W
- 4.3-inch LCD color touch screen
- Internal series/parallel connections for CH1 and CH2
- High resolution for measurement of 1 μ A low range current
- Capability to measure and display wide dynamic ranges of current
- Excellent programming/readback accuracy
- Transient response time <50 μ s
- Front and rear output terminals
- 2-wire or 4-wire remote sense
- A maximum of 512 arbitrary points with dwell time down to 1 ms; various built-in basic waveforms
- Low output ripple and noise <350 μ V_{rms}/2 mV_{pp}
- Command processing time <10 ms
- Automatic switchover between low and high range measurement
- Timing output, energy consumption analysis (IoT), data logging and analysis
- Capability to measure the minimum of 1 ms pulse current
- Three rack-units (3U), 1/2-rack form factor
- Software control
- Over voltage, over current, and over temperature protection
- Various interfaces available: USB HOST, LAN, Digital I/O, and RS232 standard; GPIB optional^[2]

Note[1]: The CH3 of DP2031 has two ranges: 6 V/5 A and 6 V/10 A (optional). When it switches to 6 V/10 A, both CH1 and CH2 switch to 32 V/2 A from 32 V/3 A.

Note[2]: The GPIB and RS232 share the same port. The optional GPIB interface can be installed in place of the RS232 interface.

3 Document Overview

This manual gives you a quick overview of the front and rear panel, user interface, and basic operation methods of DP2000 Series Programmable DC Power Supply.



TIP

For the latest version of this manual, download it from the official website of RIGOL (<http://www.rigol.com>).

Publication Number

UGH09100-1110

Software Version

00.00.01

Software upgrade might change or add product features. Please acquire the latest version of the manual from RIGOL website or contact RIGOL to upgrade the software.

Format Conventions in this Manual



1. Key

The front-panel key is denoted by the menu key icon. For example, the  indicates the "Utility" shortcut key.

2. Menu

The menu function key is denoted by the format of "Menu Name (Bold) + Character Shading" in the manual. For example, **System** indicates the "System" menu option in the operation interface. Tap **System** to access the "System" function menu.

3. Operation Procedures

The ">" denotes the next step of the operation. For example,  > **Store** indicates first tapping , and then tapping **Store**.

Content Conventions in this Manual

The following DP2000 series power supply model is available. Unless otherwise specified, this manual takes DP2031 as an example to illustrate the functions and operation methods of DP2000 series power supply.

Model	Number of Channels	Output Voltage/Current
DP2031	3	Range 1: 32 V/3 A, 32 V/3 A, 6 V/5 A

Model	Number of Channels	Output Voltage/Current
		Range 2 ^[1] : 32 V/2 A, 32 V/2 A, 6 V/10 A (optional)

Note[1]: The CH3 of DP2000 series has two ranges: 6 V/5 A and 6 V/10 A (optional). When it switches to 6 V/10 A, both CH1 and CH2 switch to 32 V/2 A.

4 Quick Start

4.1 General Inspection

1. Inspect the packaging

If the packaging has been damaged, do not dispose the damaged packaging or cushioning materials until the shipment has been checked for completeness and has passed both electrical and mechanical tests.

The consigner or carrier shall be liable for the damage to the instrument resulting from shipment. RIGOL would not be responsible for free maintenance/rework or replacement of the instrument.

2. Inspect the instrument

In case of any mechanical damage, missing parts, or failure in passing the electrical and mechanical tests, contact your RIGOL sales representative.

3. Check the accessories

Please check the accessories according to the packing lists. If the accessories are damaged or incomplete, please contact your RIGOL sales representative.

Recommended Calibration Interval

RIGOL suggests that the instrument should be calibrated every 12 months.

4.2 Appearance and Dimensions

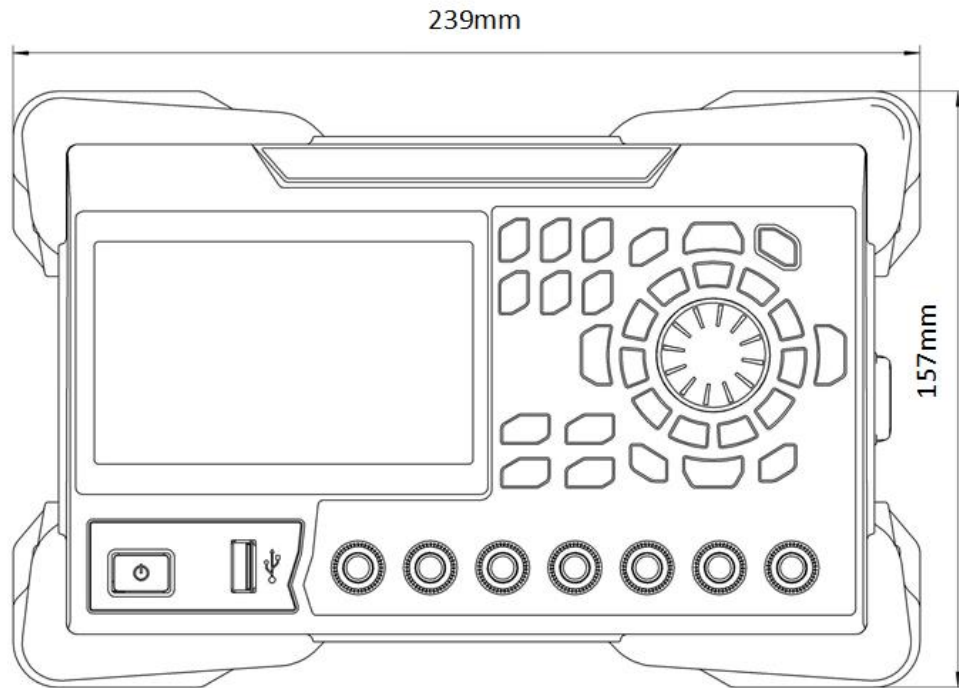

Figure 4.1 Front View

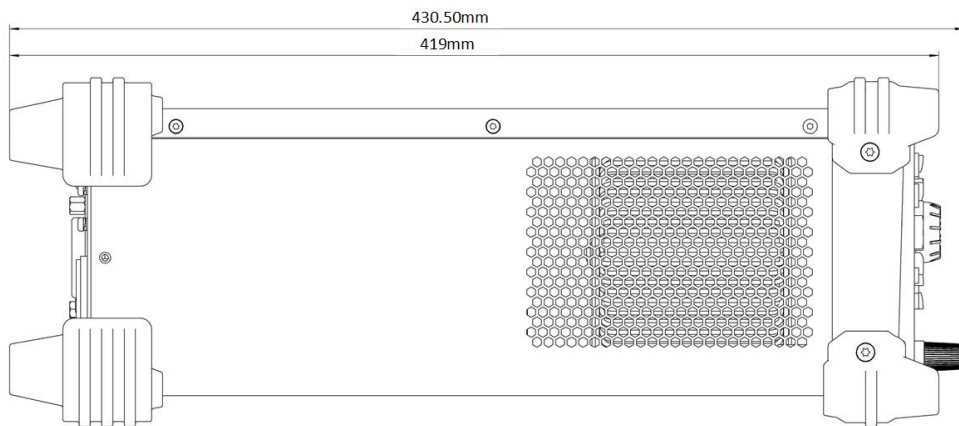

Figure 4.2 Side View

4.3 Front Panel

This section introduces the front panel of the DP2000 series by taking DP2031 (as shown in the figure below) as an example. The model-specific features will be introduced in particular.

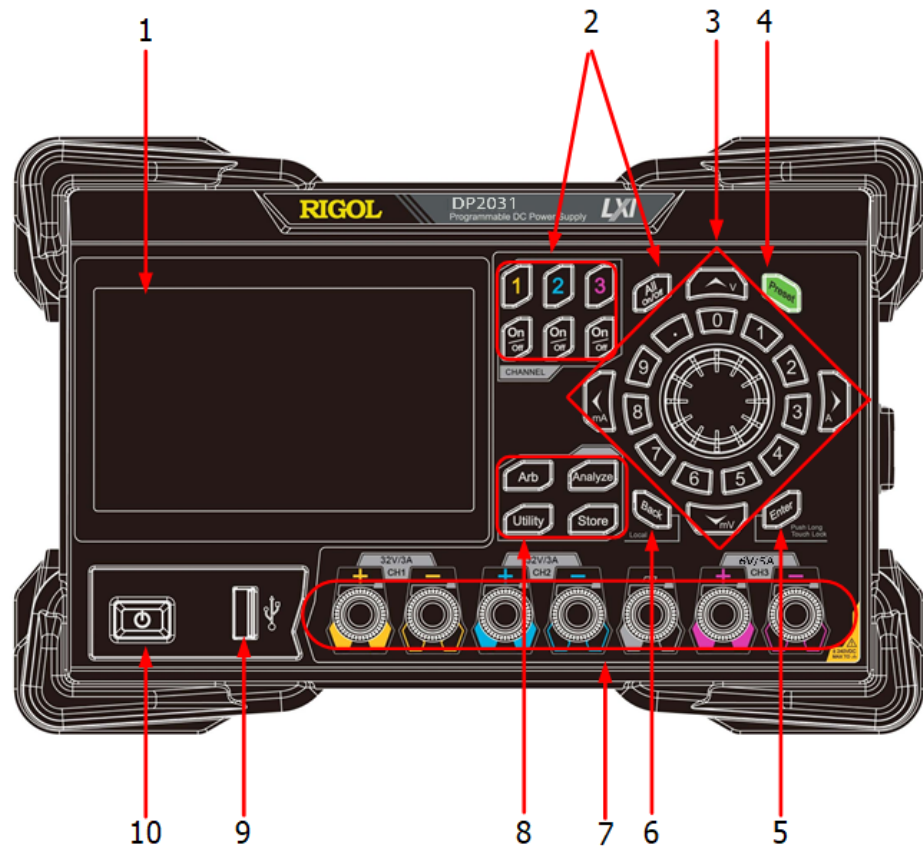



Figure 4.3 DP2000 Front Panel

1. LCD

4.3-inch TFT touch screen to display the the system parameter settings, output state, menu items, prompt messages, etc.

2. Channel Selection Keys and Output On/Off Keys

The keys are channel selection keys and output on/off keys.

 Press this key to select CH1 to control. You can set the parameters of this channel, such as voltage, current, and overvoltage/overcurrent protection.

 Press this key to select CH2 to control. You can set the parameters of this channel, such as voltage, current, and overvoltage/overcurrent protection.

 Press this key to select CH3 to control. You can set the parameters of this channel, such as voltage, current, and overvoltage/overcurrent protection.

 Pressing this key can turn the corresponding channel on or off.

 Press this key and a prompt message will be displayed asking whether to turn all channels on. Tap **OK** to turn all channels on. Pressing this key again can turn all channels off.

3. Parameter Input Area

As shown in the figure below, the parameter input area includes the arrow keys (unit selection keys), numeric keypad, and knob.

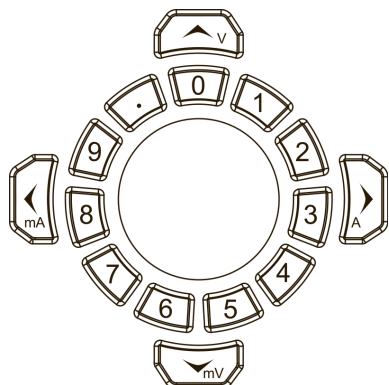

- Arrow keys/unit selection keys

Arrow keys: In normal mode, you can use the keys to navigate through the menu items; in parameter editing mode, you can use the left/right key to select the digit place or the up/down key to increment or decrement the value at the selected digit place. You can press the knob to enter or quit the parameter editing mode.

Unit selection keys: When setting parameters with front-panel numeric keypad, you can also use the arrow keys to select the unit of voltage (V/mV) or the unit of current (A/mA).

- Numeric keypad

Ring-type numeric keypad: The keypad is composed of numeric values from 0 to 9 and the decimal point. Pressing the corresponding key can directly input the number or decimal point.

- Rotary Knob

Press: When in normal mode, pressing the knob can switch to the editing mode; pressing the knob again can disable the editing mode.

Rotate: You can rotate the knob either clockwise or counter-clockwise. In normal mode, rotating the knob can navigate through the menu or menu items; after selecting an item to control, you can rotate the knob to increment or decrement the value or select options from a drop-down button.

4. Preset Key



Press the key to restore the instrument to factory default (refer to *Factory Default Values*).

5. Enter Key



Press the key to confirm your value.

Long pressing the key can lock the touch screen, for which you cannot configure the instrument using the touch screen. Long pressing the key again can unlock the touch screen.

6. Back Key



Press the key to delete the character currently before the cursor.

When the instrument is in remote control, pressing this key can return to local (front panel) operation.

7. Output terminals

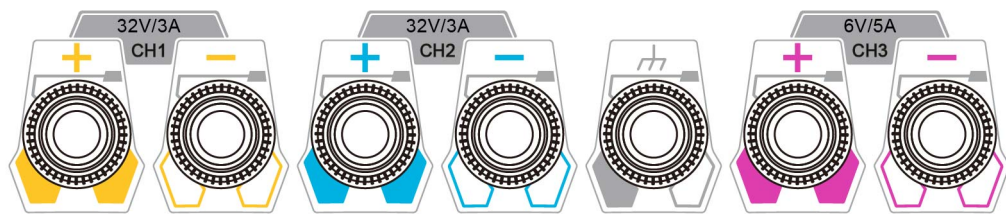

Figure 4.4 DP2000 Output Terminals

- Channel output terminals: used to output voltage and current of the channel. Please refer to *Document Overview* for available output voltage/current range of the model.
- Earth ground terminal: be connected to the instrument chassis and earth ground (the ground terminal of the power cord) and is grounded.

8. Function Menu



Press this key to enter the Arb interface, in which you can set Arb parameters, and enable/disable the Arb function.



Press this key to set the Analyzer interface, in which you can select the object to analyze and turn on/off the Logger.



Press this key to enter the Utility setting interface, in which you can set parameters related to remote interface, system, outputs, and options. Besides, you can also set the display and Sense.



Press this key to enter the Store and Recall interface, in which you can save, read, delete, copy, or paste files. The file types available for storage include state file, log file, Arb file, calibration file, option installation verification file, and bitmap file. You are allowed to store a file to internal or external memory and also recall the file from internal or external memory.

9. USB HOST Port

The instrument only supports the flash memory USB storage device of FAT32 format.

10. Power Switch Key



Press this key to power on or off the instrument.

4.4 Rear Panel

This section introduces the rear panel of DP2000 series by taking DP2031 (as shown in the figure below) as an example.

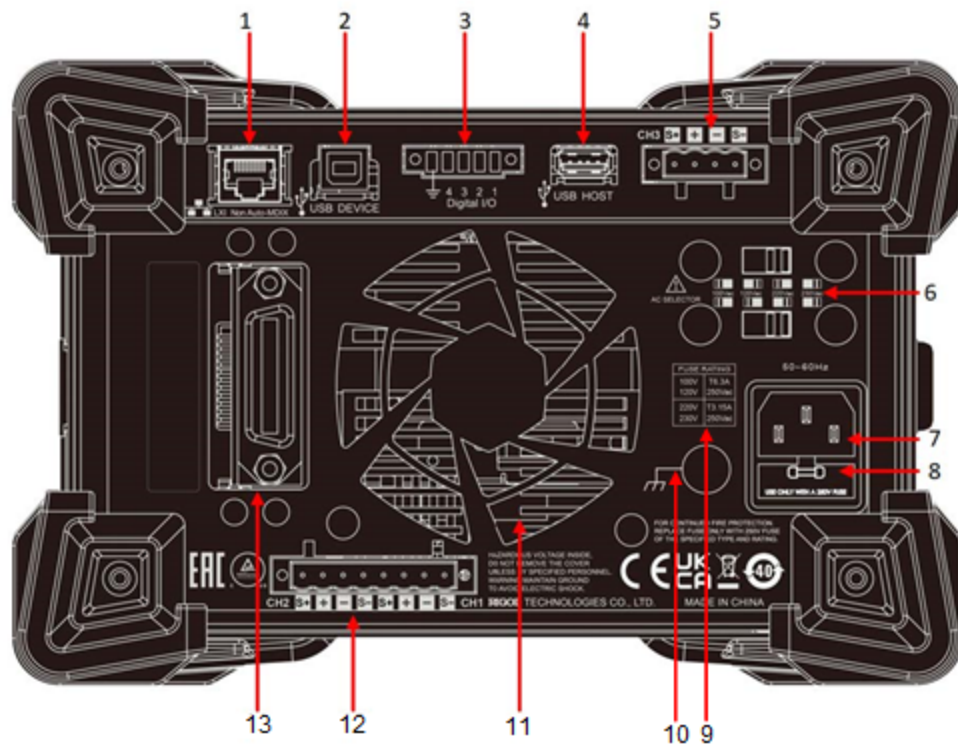

Figure 4.5 DP2000 Rear Panel

Table 4.1 DP2000 Rear Panel Description

No.	Name	Description
1	LAN port	The instrument is connected to the LAN network via RJ45 interface.
2	USB DEVICE	Connect the instrument (as "slave" device) to external USB device (such as PC).
3	Digital I/O	Digital I/O port

No.	Name	Description
4	USB HOST	Connect the instrument (as "host" device) to external USB device (such as USB storage device); extend a GPIB interface for the power supply using the USB-GPIB interface module (optional).
5	CH3	CH3 output terminal ports
6	AC selector	Select the specification of the input voltage: 100, 120, 220, or 230 (please refer to <i>Connecting to Power</i>).
7	AC power inlet socket	AC inlet power connector
8	Fuse	The fuse rating is related to the instrument model and actual input voltage (please refer to <i>Replacing the Fuse</i>).
9	AC input power requirement	The table describes the relationship between the frequency, voltage of the input power and fuse rating.
10	Ground terminal	-
11	Fan ventilation hole	-
12	CH1 and CH2	CH1&CH2 output terminal ports
13	RS232/GPIB port ^[1]	Available for RS232 or GPIB interface (optional)

Note[1]: DP2000 series provides RS232 (standard) and GPIB (optional). Sharing a physical port, those two interfaces cannot be used concurrently.

4.5 User Interface

Tap  > **Display** to assess the interface as shown in the figure below. This section introduces the meter-view display of the power supply.

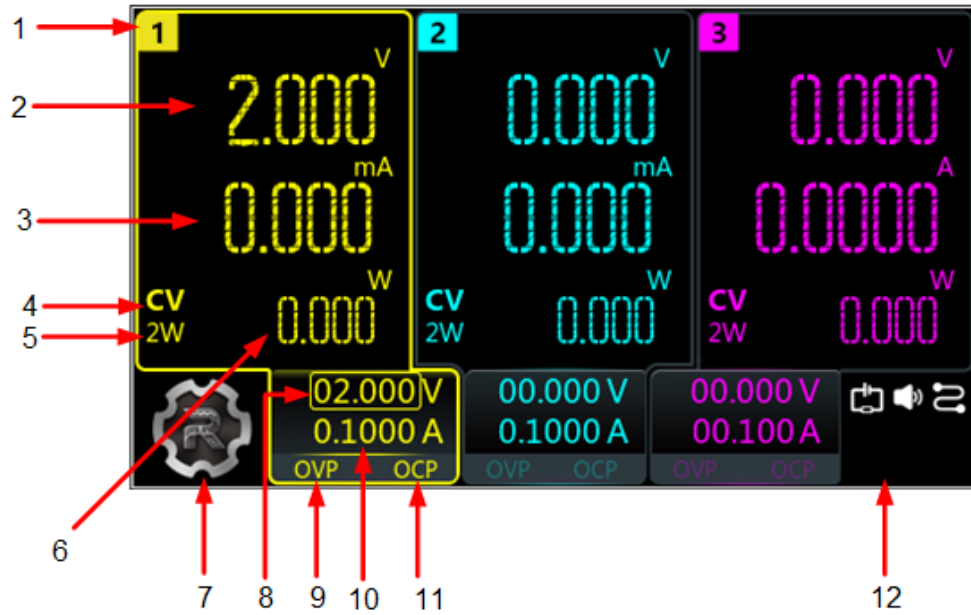













Figure 4.6 User Interface

Table 4.2 User Interface Description

No.	Description
1	Channel identifier
2	Actual output voltage
3	Actual output current
4	Output mode CV: The output is in constant voltage mode. CC: The output is in constant current mode. UR: The output is unregulated.
5	Sense connection 4W indicates that 4-wire sensing (remote sensing) measurement is in use. 2W indicates that 2-wire sensing (local sensing) measurement is in use.
6	Actual output power
7	Navigation icon

No.	Description
8	Voltage setting value
9	Over-voltage protection (OVP) status indicator, indicating the present OVP on/off state
10	Current setting value
11	Over-current protection (OCP) status indicator, indicating the present OCP on/off state
12	<p>The following icons indicate the system status.</p> <p>: CH1 and CH2 are independent of each other.</p> <p>: CH1 and CH2 are connected in series.</p> <p>: CH1 and CH2 are connected in parallel.</p> <p>: over-temperature protection is tripped.</p> <p>: the screen is locked.</p> <p>: network connected.</p> <p>: a USB device is detected.</p> <p>: the instrument is in remote control.</p> <p>: the beeper is turned off.</p> <p>: the beeper is turned on.</p> <p>: downloading the firmware upgrade file.</p>

4.6 Connecting to Power

DP2000 series power supply supports various AC power inputs. The AC selector setting on the rear panel differs when input power is different, as shown in the table below.

Table 4.3 AC input power specifications (including AC selector setting)

AC input power	AC selector
100 Vac±10%, 50 Hz to 60 Hz	100
120 Vac±10%, 50 Hz to 60 Hz	120

AC input power	AC selector
220 Vac±10%, 50 Hz to 60 Hz	220
230 Vac±10% (Max. 250 Vac), 50 Hz to 60 Hz	230

Please connect the power strictly following the steps below.

1. Check the Input Power

Please make sure that the input AC power fulfills the requirements in [Table 4.3 AC input power specifications \(including AC selector setting\)](#).

2. Check the AC Voltage Selector on the Rear Panel

Please make sure that the AC voltage selector (100, 120, 220, or 230) on the rear panel is set to match the actual input voltage. To change the input AC voltage selector on the power supply, use the two AC selector switches on the rear panel of the power supply as shown below.

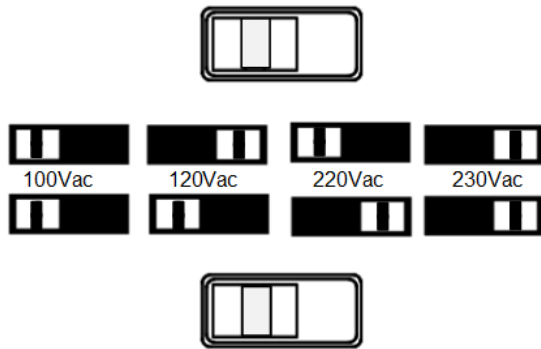

Please set the switches following the diagram above. For example, to select 100 V, slide both switches to the left; to select 220 V, slide the upper switch to the left and the lower switch to the right.

3. Check the Fuse

The instrument has been equipped with the specified fuse when it leaves factory. Please make sure that the fuse matches the actual input voltage by referring to "Input power requirement" or [Replacing the Fuse](#).

4. Connect to AC Power

Please connect the instrument to AC power using the power cord provided in the accessories.



WARNING

To avoid electric shock, please make sure that the instrument is correctly grounded.

4.7 Power-on Inspection

Press the power key on the front panel to switch on the instrument. During the start-up process, the instrument performs a series of self-tests. If the instrument passes the self-test, the welcome interface will be displayed; otherwise, the corresponding self-test failure information will be displayed.



TIP

If you want to power on the instrument again after powering it off, please make sure that the time interval between the two power-on operations is greater than 5 s.

4.8 Connecting the Outputs

This series power supply is equipped with front and rear output terminals. This section describes how to make front and rear connections.

Front Outputs Connections

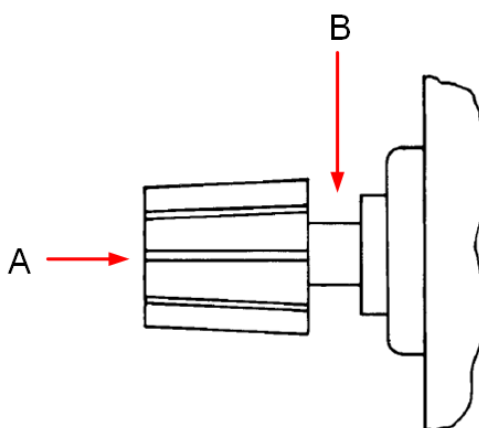

Method 1: Connect wires to the front of the terminals as shown in (A).

Method 2: Rotate the terminal block screws counter-clockwise and connect wires to the terminals in location (B). Then rotate the screws clockwise to tighten the wires. This method can help avoid errors caused by the terminal resistance.



CAUTION

Turn off AC power before making front panel connections. All wires and straps must be properly connected to prevent currents from damaging the loads.

Rear Outputs Connections

Insert the connector plug into the rear terminal. Secure the connector by tightening the locking screws.

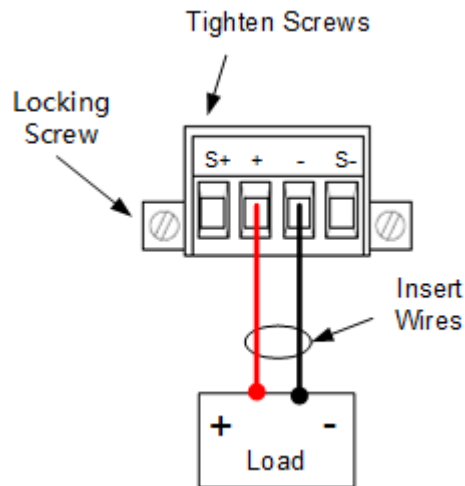
**CAUTION**

Turn off AC power before making rear panel connections. All wires and straps must be properly connected to prevent currents from damaging the loads.

**TIP**

Do not use both front and rear panel output terminals concurrently.

4.9 Replacing the Fuse

The fuse rating required depends on the instrument model and actual input voltage, as shown in the table below. You can also refer to [Table 4.3 AC input power specifications \(including AC selector setting\)](#).

Table 4.4 Fuse Rating

AC Input Voltage	Fuse Rating
100 Vac/120 Vac	T6.3 A 250 Vac
220 Vac/230 Vac	T3.15 A 250 Vac

If you need to replace the fuse, please follow the steps below.

1. Power off the instrument and remove the power cord.
2. Insert a small straight screwdriver into the slot at the power socket and pry out the fuse holder gently.

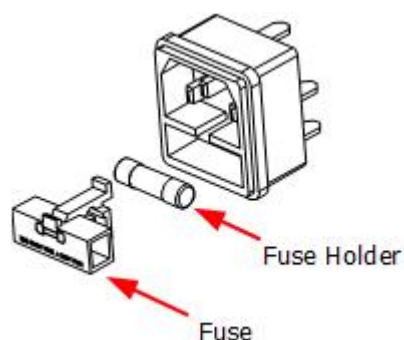

3. If necessary, please adjust the AC selector setting manually to select the voltage that matches the actual input voltage (please refer to [Connecting to Power](#)).
4. Remove the original fuse and insert the proper fuse into the fuse holder (please refer to the "Input power requirement" or [Replacing the Fuse](#)).
5. Re-insert the fuse holder into the power socket (please pay attention to the direction).



WARNING

To avoid personal injury, please power off the power supply before replacing the fuse; to avoid electric shock or fire, select the input power that matches the actual input voltage and use the correct fuse before connecting to power.

4.10 Using the Built-in Help System

Tap  > **Help** to enter the help interface as shown in the figure below. The built-in help system can help you learn about the instrument, obtain a list of help topics, and update instrument firmware.

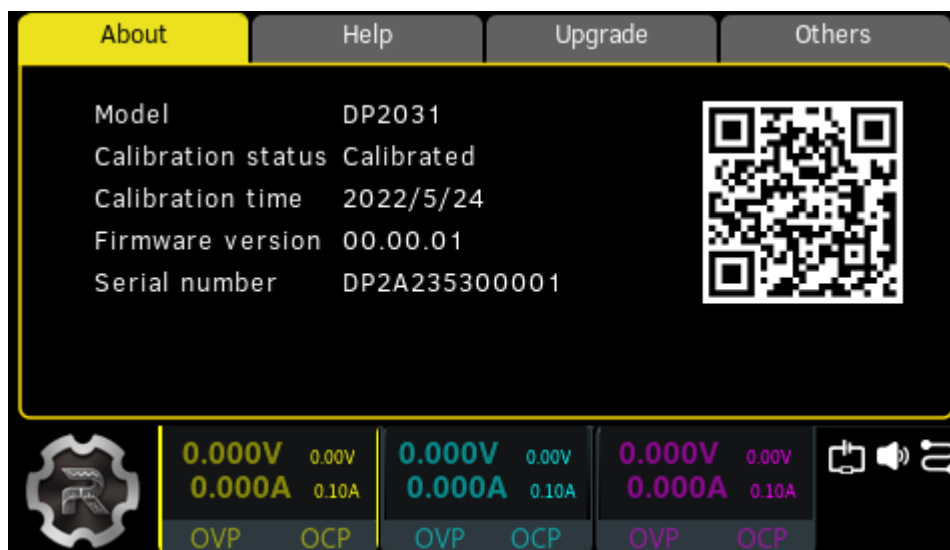

Figure 4.7 Help Interface

About

Tap **About** to view the system information of the instrument, including the instrument model number, serial number, firmware version, and calibration time.

Help

Tap **Help** to view the help information for front-panel keys or menu keys. You can tap a function key topic at the left side to obtain a detailed description of its function.

Upgrade

Tap **Upgrade** to access the software upgrade interface. You can read the USB storage device and tap **Upgrade** to update instrument firmware. You can also connect the instrument to network and then tap **Remote** to download the firmware upgrade file (📁 is displayed in the notification area in the process). After the file is downloaded, the instrument restarts in 2 seconds and starts to upgrade.

Others

Tap **Others** to enter the interface in which you can obtain the following help topics:

- View the last displayed message
- View remote command error queue
- Contact RIGOL Technical Support
- Open source statement

5 Using the Protection Function

Each channel output has independent over-voltage protection (OVP) and over-current protection (OCP) functions. The “OVP” / “OCP” status indicator is lit when a protection function is enabled.

Overvoltage Protection (OVP)

When OVP is enabled, the output will be disabled when the output voltage reaches the voltage limit setting.

Tap  > **Display** to enter the meter view for multiple outputs. Then you can tap one of the channel labels at the bottom to open the meter view for a single channel. For example, you can configure CH1 output settings in its meter view, as shown in the figure below.

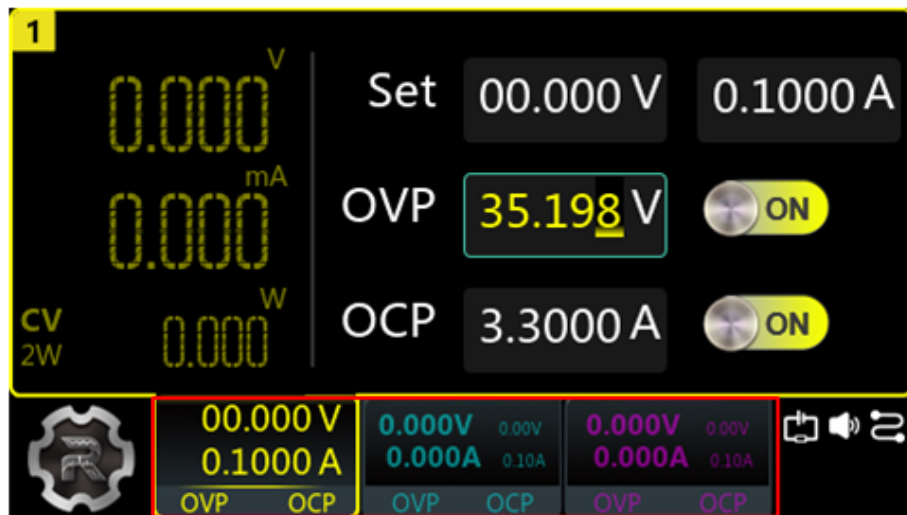

Channel Labels

Figure 5.1 CH1 Output Settings Interface

You can set the OVP value in the following ways.

- Tap the “OVP” input field and set the limit value with the pop-up numeric keypad.
- Rotate the knob or use the arrow keys to select the “OVP” input field. Then press the knob to enter the editing mode. After that, you can either use the front panel numeric keypad to directly enter the value or use the up/down arrow keys to increment or decrement the value in the specified digit place. Press the knob again to disable the editing mode.

After finishing the voltage limit setting, you can click or tap the “OVP” on/off button to turn ON or OFF the OVP function.

Overcurrent Protection (OCP)

When OCP is enabled, the output will be disabled when the output current reaches the current limit setting.

You can tap  > **Display** to enter the meter view for multiple outputs. Then you can tap one of the channel labels at the bottom to open the meter view for a single channel. For example, you can configure CH1 output settings in its meter view, as shown in *Figure 5.1*.

You can set the OCP value in the following ways.

- Tap the “OCP” input field and set the value with the pop-up numeric keypad.
- Rotate the knob or use the arrow keys to select the “OCP” input field. Then press the knob to enter the editing mode. After that, you can either use the front panel numeric keypad to directly enter the value or use the up/down arrow keys to increment or decrement the value in the specified digit place. Press the knob again to disable the editing mode.

After finishing the current limit setting, you can click or tap the “OCP” on/off button to turn ON or OFF the OCP function.

OCP Delay

The power supply may momentarily has a peak current value beyond the OCP value when it is turned on, when an output value is programmed, or when the output load is connected. In most cases, these temporary conditions would not be considered an over-current protection fault, and you do not need to disable the output. The series power supply ignores this status bit during the specified delay period (10 ms by default). Once the OCP delay time has expired and if the current is still beyond the limit, the output will shut down.

You can also set the OCP delay period by sending :OUTPut:OCP:DELAy [CH1|CH2|CH3], {<value>|MINimum|MAXimum} SCPI command (refer to the series *Programming Guide*). The delay can be programmed from 0 to 1000 ms.

6 Constant Voltage Output

The series power supply provides three output modes: constant voltage (CV), constant current (CC), and unregulated (UR). In CV mode, the output voltage equals to the voltage setting value, and the output current is determined by the load; whereas in CC mode, the output current equals to the current setting value, and the output voltage is determined by the load. UR mode is the unregulated state between CV and CC mode. This chapter introduces how to make the instrument operate in CV mode.

Operation Procedures:

1. Connect the load to the channel output terminals (please refer to [Connecting the Outputs](#)).



CAUTION

While making connections, pay attention to the polarity to avoid damaging the instrument or the devices connected to the instrument.

2. Press the power key to start the instrument and the meter view appears.
3. Set the voltage

Method 1:

You can use the front-panel parameter input area to set the voltage.

- a. Use the knob or arrow keys to select the voltage field in meter view or in channel output settings interface.
- b. Press the knob and the input box turns blue, indicating that the selected field can be edited.
- c. Use the left/right arrow keys to select the digit place and then rotate the knob or use the up/down arrow keys to adjust the value in the selected place. You can also directly set the voltage by using the front-panel numeric keypad. The default unit is V.
- d. Press the knob again to disable the editing mode.



TIP



In meter view, if you select a current "Set" field to edit, you can still set the voltage by using the front-panel numeric keypad to set the value and then pressing the unit selection key



Method 2:

You can also use the touch screen function to set the voltage.

In the channel output settings interface, tap the voltage "Set" field and use the pop-up numeric keypad to enter the value and unit.

You can tap  on the virtual keypad or press  on the front panel to delete the character before the cursor.

4. Set the current

Method 1:

You can use the front-panel parameter input area to set the current.

- a. Use the knob or arrow keys to select the current field in meter view or in channel output settings interface.
- b. Press the knob and the input box turns blue, indicating that the selected field can be edited.
- c. Use the left/right arrow keys to select the digit place and then rotate the knob or use the up/down arrow keys to adjust the value in the selected place. You can also directly set the current by using the front panel numeric keypad. The default unit is A.
- d. Press the knob again to disable the editing mode.

TIP



In meter view, if you select a voltage "Set" field to edit, you can still set the current by using the front panel numeric keypad to set the value and then pressing the unit selection key



Method 2:

You can also use the touch screen function to set the current.

In the channel output settings interface, tap the current "Set" field and use the pop-up numeric keypad to enter the value and unit.

You can tap  on the virtual keypad or press  on the front panel to delete the character before the cursor.

5. Set the OCP

Set the OCP value (refer to [Using the Protection Function](#)) and then tap **OCP** on/off button to enable the OCP function. The output will be disabled automatically when the actual output current reaches the OCP value.

6. Enable the output

Pressing the channel on/off key  can turn on the respective channel output. When a channel is turned on, its on/off key is illuminated. Rather, when the



channel is turned off, the light will be off. You can press  to turn all outputs on or off simultaneously.



WARNING

To avoid electric shock, please turn on the output after the output terminals are correctly connected.

7. Check the output mode

In CV mode, the displayed output mode is "CV"; if "CC" is displayed, increase the current value properly and the power supply will switch to CV mode automatically.



TIP

In CV output mode, when the load current is greater than the current setting value, the power supply will switch to CC mode automatically. At this time, the output current equals to the current setting value, and the output voltage can be calculated by the current times the load impedance.

7 Constant Current Output

In CC mode, the output current equals to the current setting value, and the output voltage is determined by the load. This chapter introduces how to make the instrument operate in CC mode.

Operation Procedures:

1. Connect output terminals

Please connect the load to the channel output terminals on the front panel (please refer to *Connecting the Outputs*).

2. Press the power switch to start the instrument.

3. Set the voltage

Set your desired voltage value (refer to *Constant Voltage Output*).

4. Set the current

Set your desired current value (refer to *Constant Voltage Output*).

5. Set the OVP

Set the proper OVP value (refer to *Using the Protection Function*) and then enable the OVP function by tapping **OVP** on/off button. The output will be disabled automatically when the actual output voltage reaches the OVP value.

6. Enable the output

Please turn on the output (refer to *Constant Voltage Output*).



WARNING

To avoid electric shock, please turn on the output after the output terminals are correctly connected.

7. Check the output mode

In CC mode, the output mode displayed should be "CC"; if "CV" is displayed, increase the voltage value properly and the power supply will switch to CC mode automatically.



TIP

In CC mode, when the load voltage is greater than the voltage setting value, the power supply will switch to CV output mode automatically. At this time, the output voltage equals to the voltage setting value, and the output current can be calculated by the voltage divided by the load impedance.

8 Series/Parallel Connections

Connecting two or more isolated channels in series provides a greater voltage capability while connecting two or more isolated channels in parallel provides a greater current capability. The series power supply supports both internal and external series/parallel connections.



TIP

- The three channels of the power supply are electrically isolated with independent outputs. For a single power supply, any two of the three channels can be externally connected in series/parallel.
- Isolated channels of different power supplies can be externally connected in series/parallel.
- CH1 and CH2 can be internally connected in series/parallel.
- When in internal series mode, CH1 and CH2 cannot be externally connected in parallel; when in internal parallel connection mode, CH1 and CH2 cannot be externally connected in series.
- The parameter settings for series and parallel connections must comply with the safety requirements.

8.1 Series Connections

Connecting outputs in series provides a greater voltage capability than can be obtained from a single output. The total voltage is the sum of the individual voltages of all channels connected in series. To connect outputs in series, you need to ensure identical current ratings for each channel.



WARNING

To avoid shock hazard, please do not touch the output terminals when the output voltage exceeds 60 V in series mode.

Internal Series Connections

This series power supply supports internal series connection for CH1 and CH2. In internal series connection mode, the output voltage is twice the voltage setting. The output voltage and current are displayed in CH1 meter view, as is shown in the figure below.

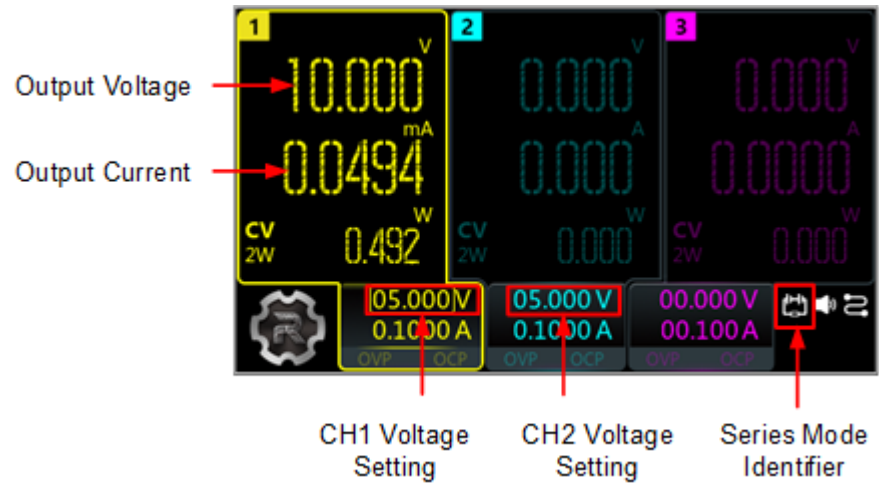
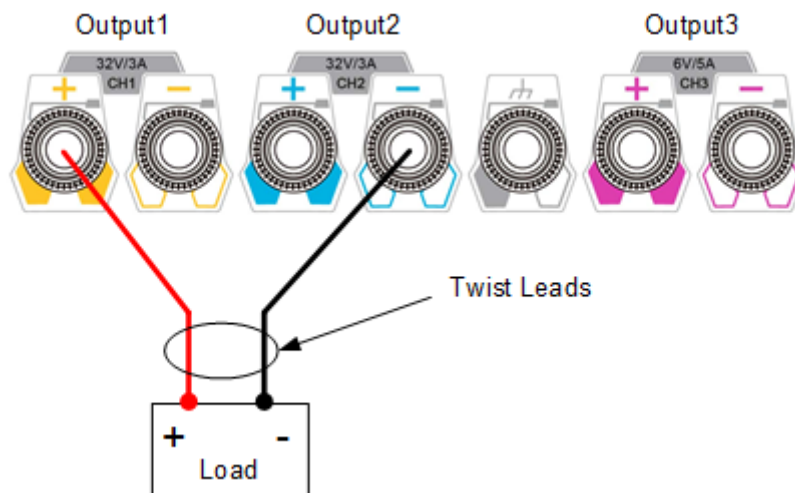
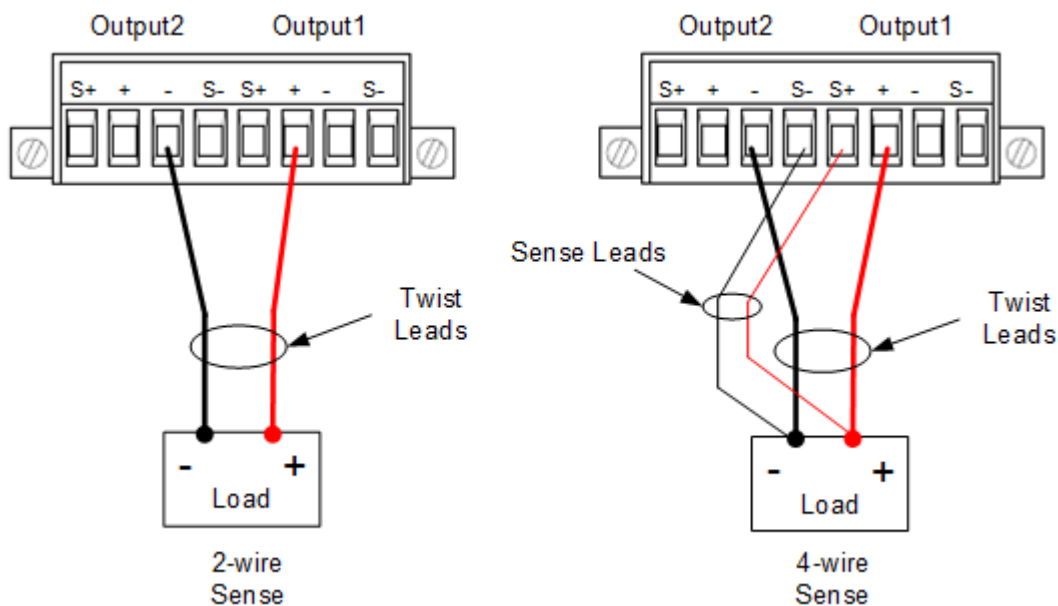

Figure 8.1 Series Output Interface

The figure below shows how to connect front output terminals to a single load in internal series mode. Please refer to *Output Connection* for internal parallel connection.



If voltage drop in the load leads is a concern, please connect the sense leads to load (refer to *Sense Settings*). The connections on the rear panel in internal series mode is shown in the figure below.

**TIP**

- In internal series/parallel connections, CH1 and CH2 always have identical voltage and current settings.
- The output voltage displayed in CH1 meter view is twice the voltage setting. CH2 has no reading.
- In internal series mode, the output voltage at the terminal is twice the voltage setting. To avoid damage to the load, please set proper voltage values

External Series Connections

This series power supply supports external series connection for multiple channels (from a single power supply or multiple power supplies). The figure below illustrates how to connect two channels when in external series mode.

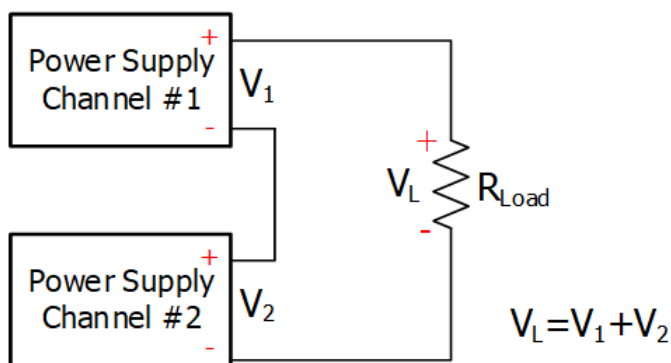

Figure 8.2 External Series Circuit

Operation Procedures:

1. Connect the power supply to load as shown in the figure above. Pay attention to the polarity when making connections.

- Set proper voltage, current, and over-current protection value for each channel (refer to *Constant Voltage Output*) and turn on the channel outputs. All the channels connected in series should be set to CV mode and have identical current setting value and OCP value.



CAUTION

Please make sure that all the channels connected in series operate in CV mode. One of the channels operating in CC mode can cause unregulated output mode for the other channels.

8.2 Parallel Connections

Connecting outputs in parallel provides a greater current capability than can be obtained from a single output. The total current is the sum of the individual currents of all channels connected in parallel. To connect outputs in parallel externally, you need to ensure identical voltage value and OVP value for each channel.

Internal Parallel Connections

This series power supply supports internal parallel connection for CH1 and CH2. In internal parallel connection mode, the output current (up to 6 A) is twice the current setting. The output voltage and current are displayed in CH1 meter view, as is shown in the figure below.

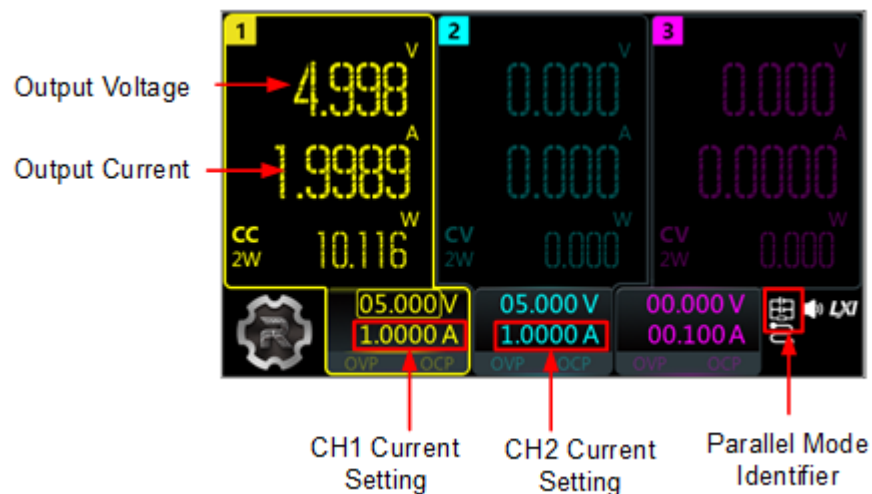
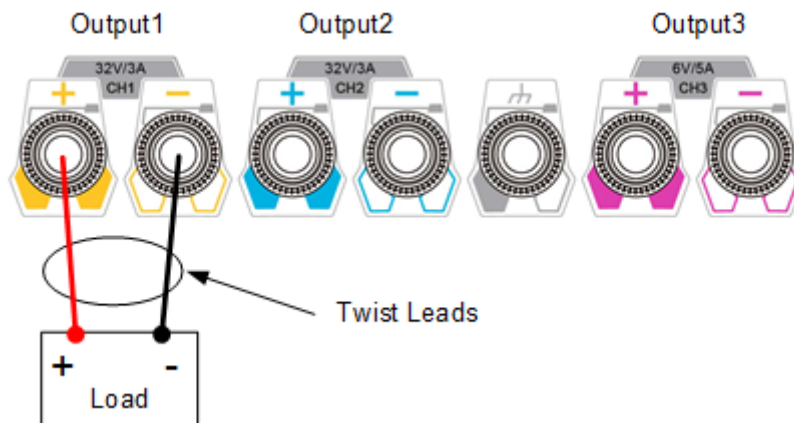
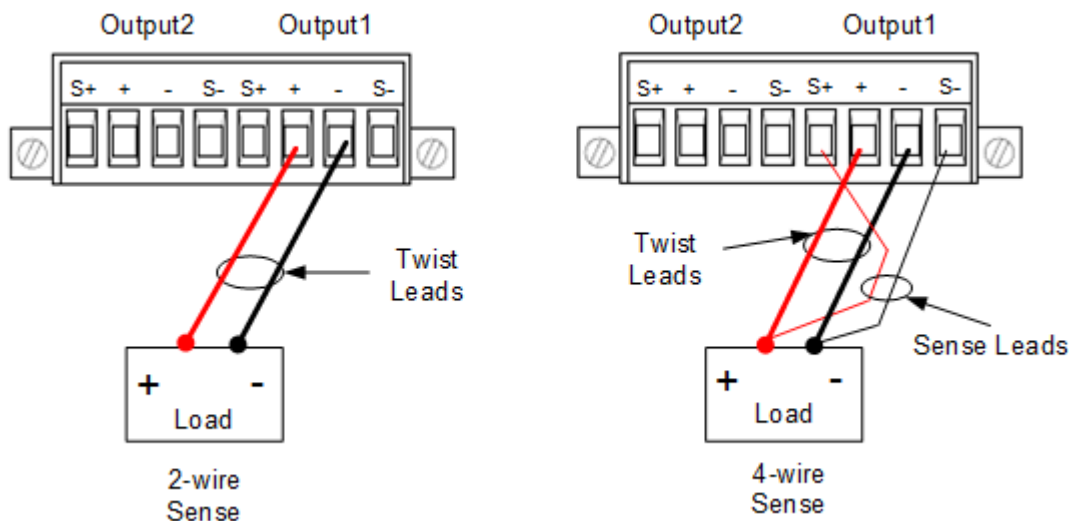

Figure 8.3 Parallel Output Interface

The figure below shows how to connect front output terminals to a single load in internal parallel mode. Please refer to *Output Connection* for channel connection.



If voltage drop in the load leads is a concern, please connect the sense leads to load (refer to [Sense Settings](#)). The figure below shows how to connect rear output terminals to a load in internal parallel mode.



TIP

In internal series/parallel connections, CH1 and CH2 always have identical voltage and current setting value.

External Parallel Connections

This series power supply supports external parallel connection for multiple channels (from a single power supply or multiple power supplies). The figure below illustrates how to connect two outputs in external parallel.

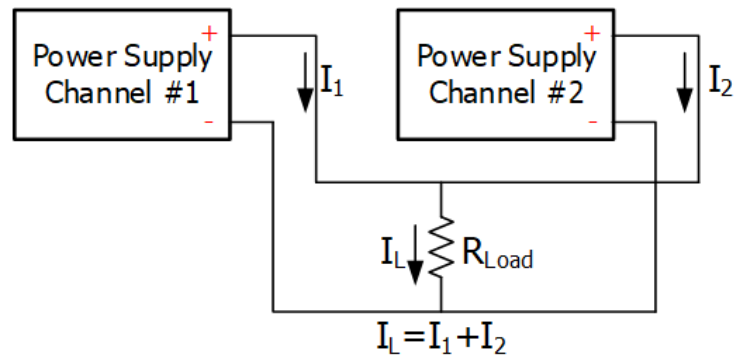

Figure 8.4 External Parallel Circuit

Operation Procedures:

1. Connect the power supply to load as shown in the figure above. Pay attention to the polarity when making connections.
2. Set proper parameters for each channel (refer to *Constant Voltage Output* and *Constant Current Output*) and turn on the output of each channel. All channels can work in CV mode or CC mode.





CAUTION

All the channels can work in CV or CC mode according to the actual need of the load.

9 Arb Function

The Arbitrary function of DP2000 series power supply enables you to generate freely programmable waveforms which can be reproduced within the limit settings for voltage and current. You can set the repetition cycle for the arbitrary waveform as well as the output voltage/current and time for each group of data. Moreover, the instrument has multiple built-in waveform templates for you to select and edit. You can set your waveform parameters based on those templates. The instrument will output waveforms according to the parameters set.

Press  or tap  > **Arb** to enter the Arb main interface, as shown in the figure below. Then tap the channel selection drop-down button at the lower-left corner of the interface to select a channel to control. The menu keys and their functions are as follows:

- **Run/Stop:**
Turn on or off the arbitrary waveform generator.
- **Setting:**
Open the Arb settings interface to set the output properties for the arbitrary waveform.
- **Import:**
Read Arb file.
- **Export:**
Save the Arb parameters edited.
- **Edit:**
Access the Arb editor to edit the data.

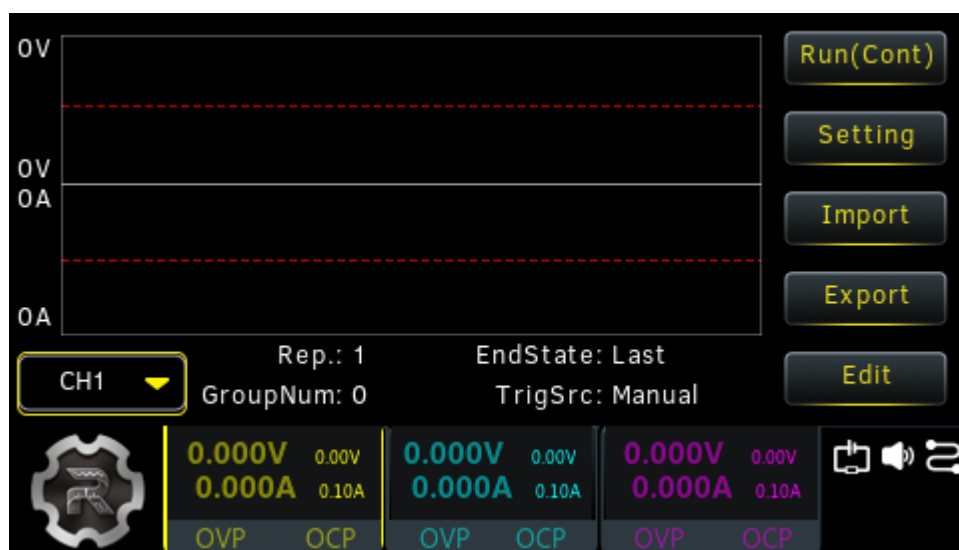

Figure 9.1 Arb Main Interface

9.1 Setting Arb Properties

After entering the Arb main interface, tap **Setting** to enter the Arb settings interface as shown in the figure below. The selected channel is highlighted at the lower-left corner of the interface.



Figure 9.2 Arb Settings Interface

In the interface, you can set the following output properties for the arbitrary waveform.

Repetition Cycle

The repetition cycle is the number of times that the arbitrary waveform is repeated based on the preset voltage/current and time. You can tap the **Rep.** input field to set the desired repetition cycle by using the touch screen or the front-panel numeric keypad. The repetition cycle can be set from 1 to 99999. Entering "0" in the field will set the repetition cycle to "infinity" .

End State

End state is the instrument state after the output sequence completes the output of all voltage/current values when the repetition cycle is set to a finite value. You can tap the **EndState** drop-down button to select "Off" or "Last" .



- Off: The output of the selected channel is turned off automatically after the output sequence completes.
- Last: The instrument remains at the last voltage and current values after the output sequence completes.

**TIP**

If the repetition cycle is set to "Infinity" , the end state is not available.

Run Mode

Run mode is the output state of the selected channel once the generator is turned on. You can tap the **RunMode** drop-down button to select "Continuous" or "Single" .

- When the run mode is set to "Continuous" , tap **Run(Cont)** in the Arb main interface and the instrument will repeat the sequence continuously based on the number of data groups and repetition cycle currently set.
- When the run mode is set to "Single" , tap **Run(Sgl)** and the button for running a single arbitrary point  will be displayed, as shown in the figure below. Each time you tap , the instrument will output a single group of data in order. The current output group number and repetition cycle are displayed at the bottom of the interface.

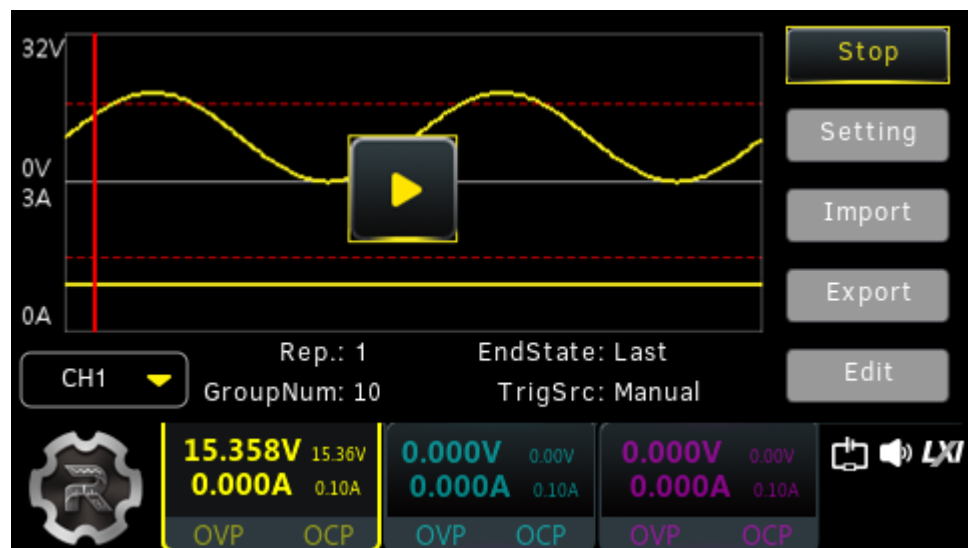
**Trigger Source**

Trigger source specifies the way of starting the output of the arbitrary sequence. You can tap the **TrigSrc** drop-down button to select "Manual" or "BUS" .

- Manual:
 - Selects the Run/Stop key as a trigger source. When the run mode is set to "Continuous" , tap **Run(Cont)** and the instrument will repeat the sequence continuously based on the number of data groups and repetition cycle currently set.
 - When the run mode is set to "Single" , tap **Run(Sgl)** and then tap  to output a single group of data.

- **BUS:** Selects a remote command as a trigger source. You can send SCPI commands to control the Arb sequence output. In the Arb main interface, tap **Run(Cont)** or **Run(Sgl)** and a prompt message "Wait for Trigger signal..." will be displayed. The instrument will start or stop the waveform output according to the received SCPI command. Please refer to *DP2000 Series Programmable Linear DC Power Supply Programming Guide* for available SCPI commands.

Apply or Back

Tap **Apply** to save the current settings and return to the Arb main interface. Otherwise, tap **Back** to cancel the current settings and return to the main interface.



TIP

The settings are valid only for the selected channel. You can change the selected channel in *Figure 9.2* through pressing the specified channel selection key on the front panel. You can also select the channel in *Figure 9.1* using the touch screen.

9.2 Arb Editor

After entering the Arb main interface, you can tap **Edit** to access the Arb editor interface, as shown in the figure below. The Arb editor allows you to create each single point of a waveform and freely edit individual points. You can also edit the Arb parameters based on the instrument's built-in waveform templates.



Figure 9.3 Arb Editor Interface

As shown in the figure above, the table displays 4 groups of data per page. You can view and edit data of other groups in the following ways.

- Tap **Prev** or **Next** to turn pages.

- Tap the page input field and input the page number to jump to by using the pop-up virtual keypad or the front-panel numeric keypad.
- Tap the “No.” cell at the upper-left of the table and input the number to jump to the specified row by using the pop-up virtual keypad or the front-panel numeric keypad.

9.2.1 Inserting a Single Point

In the Arb editor interface, you can tap **Single** to insert one group of data in the currently selected row (1 V default voltage, 1 A default current, and 1 s default time). You can set the voltage/current/time for each group by using the touch screen or the numeric keypad on the front panel.



TIP

- If the currently selected row is empty and the row above the selected row has data inserted, tap **Single** and one group of data will be inserted in the selected row.
- If the currently selected row has data inserted, tap **Single** and a group of data will be inserted in the selected row with the original group of data moved to the next row.

9.2.2 Editing Waveform Templates

The instrument provides multiple built-in output templates based on which you can create and edit arbitrary waveforms.

Tap **Templet** to open the template editing menu, as shown in the figure below. You can edit and create your desired waveform in the following steps.

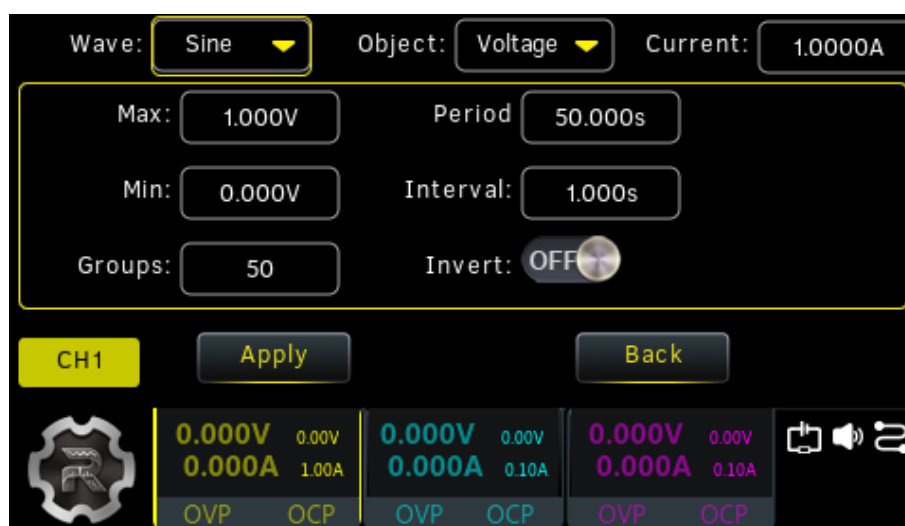

Figure 9.4 Template Editing Menu

1. Select Waveform Templates

Tap the **Wave** drop-down button to select a waveform template. Available waveform templates include Sine, Pulse, Ramp, Stair UP, Stair Dn, StairUpDn, Exp Rise, and Exp Fall.

- **Sine**

The Sine waveform is as shown in the figure below. Setting the maximum and minimum value creates the amplitude. Setting the period (T) and time interval creates the total number of points (P) in a complete period. Thus, a Sine waveform is created. Setting the inserted groups (G) determines the number of groups to be inserted in the Arb editor.

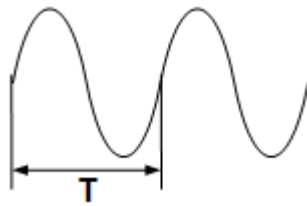

- **Pulse**

The Pulse waveform is as shown in the figure below. Setting the maximum and minimum value creates the amplitude. Setting the positive pulse width (t) determines the duration of high levels. The currently set period (T) minus the positive pulse width (t) is the duration of low levels. Setting the inserted groups (G) determines the number of groups to be inserted in the Arb editor.

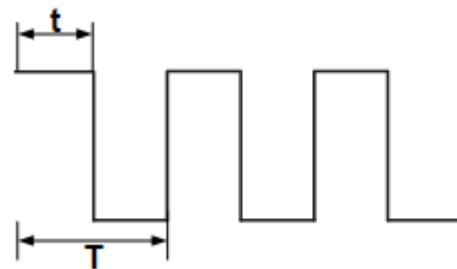

- **Ramp**

The Ramp waveform is as shown in the figure below. Setting the maximum and minimum value creates the amplitude. Setting the period (T) and time interval creates the total number of points (P) in a complete period. Setting the symmetry (Sym) creates the Ramp waveform. The rising edge of the Ramp waveform has $\text{int}(P \cdot \text{Sym})^{[1]}$ points and the falling edge has $P - \text{int}(P \cdot \text{Sym})$ points.

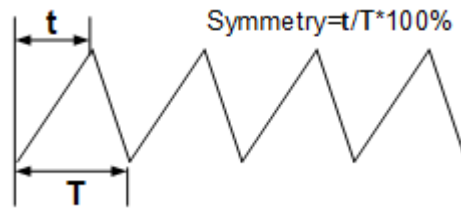

Note^[1]: $\text{int}(P * \text{Sym})$ refers to rounding $P * \text{Sym}$ (to discard the decimal part).

- Stair Up

The Stair Up waveform is as shown in the figure below. Setting the maximum (MAX), minimum (MIN), period, and total number of steps (N) creates the Stair Up waveform. The number of steps (N) ranges from MIN to MAX. The step size is $(\text{MAX} - \text{MIN}) / (N - 1)$. $\text{Interval} = \text{Period} / \text{Number of Steps}$.

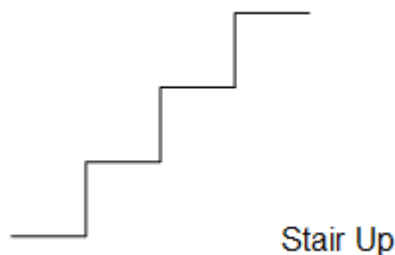

- Stair Dn

The Stair Dn waveform is as shown in the figure below. Setting the maximum (MAX), minimum (MIN), period, and total number of steps (N) creates the Stair Dn waveform. The number of steps (N) ranges from MIN to MAX. The step size is $(\text{MAX} - \text{MIN}) / (N - 1)$. $\text{Interval} = \text{Period} / \text{Number of Steps}$.



- Stair UpDn

The Stair UpDn waveform is as shown in the figure below. Setting the maximum (MAX), minimum (MIN), period (T), and total number of steps (N) creates the Stair UpDn waveform. When N is odd, the waveform rises from MIN to MAX by step size of $(\text{MAX} - \text{MIN}) / \text{int}(N/2)$ and then drops to MIN by the same step size. When N is even, the waveform rises from MIN to MAX by step size of (MAX-

$\text{MIN}/\{(N/2)-1\}$ and then drops to MIN by step size of $(\text{MAX}-\text{MIN})/(N/2)$.
Interval=Period/Number of Steps.

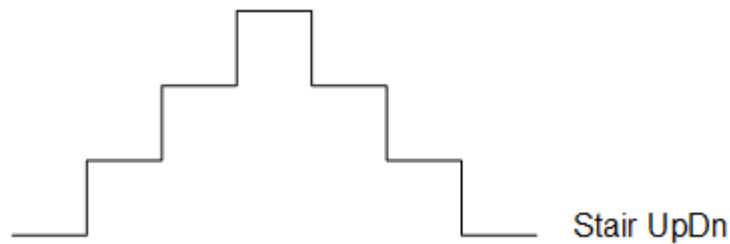

- Exp Rise

The Exp Rise waveform is as shown in the figure below. Setting the maximum (MAX), minimum (MIN), inserted groups (total number of points, denoted by P), interval, and rise index (denoted by RiseIndex) creates the Exp Rise waveform. The waveform function is $(\text{MAX}-\text{MIN}) \cdot (1 - e^{-i \cdot \text{RiseIndex}/P})$; wherein, "i" is independent variable ranging from 0 to (P-1).



- Exp Fall

The Exp Fall waveform is as shown in the figure below. Setting the maximum (MAX), minimum (MIN), inserted groups (total number of points, denoted by P), interval, and fall index (denoted by FallIndex) creates the Exp Fall waveform. The waveform function is $(\text{MAX}-\text{MIN}) \cdot e^{-i \cdot \text{FallIndex}/P}$; wherein, "i" is independent variable ranging from 0 to (P-1).



TIP

When the template selected is Exp Rise or Exp Fall, the maximum or minimum value cannot be reached due to the characteristic of the exponential function itself. The available range depends on the rise/fall index currently set. The larger the rise/fall index, the wider the

range, as shown in the figures below (maximum=8, minimum=0, total number of points=100, rise index/fall index: 1, 4, 7 and 10).

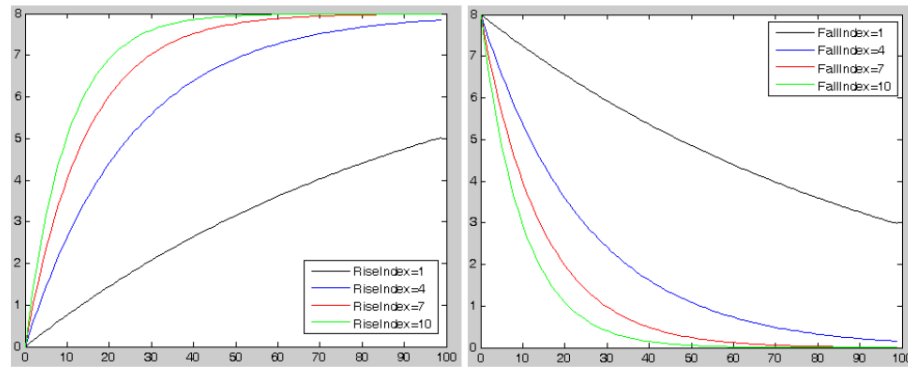

2. Select Voltage/Current to Edit

Tap the **Object** drop-down button and select "Voltage" or "Current" to edit.

- Voltage: When voltage is selected, the output current of all groups is fixed. You can tap the **Current** input field to set the current value using the touch screen or the parameter input area on the front panel.
- Current: When current is selected, the output voltage of all groups is fixed. You can tap the **Voltage** input field to set the voltage value using the touch screen or the parameter input area on the front panel.

3. Edit Arb Parameters

When selecting different waveform templates, you need to edit different parameters. Please refer to the table below for details.

Table 9.1 Arb Parameters (Template)

Template	Parameters
Sine	Max, Min, Period, Interval, Groups, Invert On/Off
Pulse	Max, Min, Period, Positive Pulse Width, Groups, Invert On/Off
Ramp	Max, Min, Period, Interval, Groups, Symmetry, Invert On/Off
Stair Up	Max, Min, Period, Steps, Groups
Stair Dn	Max, Min, Period, Steps, Groups
StairUpDn	Max, Min, Period, Steps, Groups

Template	Parameters
Exp Rise	Max, Min, Groups, Interval, Exp
Exp Fall	Max, Min, Groups, Interval, Exp

- **Max**

Set the maximum voltage/current of the template currently selected. The available range is related to the channel currently selected. The max value should be greater than or equal to the min value currently set.

- **Min**

Set the minimum voltage/current of the template currently selected. The available range is related to the channel currently selected. The min value should be smaller than or equal to the max value currently set.

- **Period**

Set the duration of a cycle for the waveform currently selected. The max period is 3600 s.

- **Interval**

Set the time interval between two points (the time required for the instrument to output each group of data) of the template currently selected. The maximum interval is 3600 s.

- **Groups**

Set the number of points selected from the waveform at equal intervals. The available range is from 1 to 512.

- **Invert**

When the template currently selected is Sine, Pulse, or Ramp, if Invert is turned on, the instrument will first turn the preset waveform upside down and then create the output waveform.

- **Positive Pulse Width**

When the template currently selected is Pulse, you can set the positive pulse width (namely the duration of high levels within a period). The maximum pulse width is 3600 s. The actual available positive pulse width depends on the period currently set.

- **Symmetry**

When the template currently selected is Ramp, you can set the symmetry (namely the ratio of the duration of the rising edge within a period to the whole period). The range is from 0% to 100%.

- **Steps**

When the template currently selected is Stair Up, Stair Dn, or Stair UpDn, you can set the total number of points within a complete period. The available range is from 3 to 99999.

- **Exp**

When the template currently selected is Exp Rise, you can set the rise index which ranges from 0 to 10.

When the template currently selected is Exp Fall, you can set the fall index which ranges from 0 to 10.

4. Apply Settings

After editing the Arb parameters (template), tap **Apply** to create the arbitrary waveform. Its Arb parameters will be displayed in the Arb editor as shown in *Figure 9.3*.

9.2.3 Delete

In the Arb editor interface (*Figure 9.3*), you can tap **Delete** to delete the selected group of data. If the selected row has no data, a prompt message “No data in the unit” will be displayed.

Tap **Clear** and a prompt message “Clear all groups?” will be displayed. Tapping **Yes** will remove all data in the table.

9.3 Import and Export

You can save the Arb parameters to internal or external memory and recall them when required.

Export

After editing the parameters, you can tap **Export** to access the store and recall interface. Select the desired storage path and then tap **Save**. Set the filename in the pop-up filename input field. A prompt message “Arb file is exported successfully” will be displayed. The file type is fixed to “.RTF”.

Import

Tap **Import** to access the store and recall interface. Select the file that you want to read and then tap **Read**. A prompt message “Arb file is imported successfully” is displayed and the instrument goes back to the Arb main interface. You can edit the imported Arb file.

9.4 Enabling the Arb Output

After editing the Arb parameters, you can go back to the Arb main interface and turn on waveform output based on settings in *Trigger Source*. The figure below shows the Arb output interface.



Figure 9.5 Arb Output Interface





TIP

- Enabling the output will change the channel output value. Please make sure that the change of the output value will not affect the devices connected to the power supply before turning on the output.
- When the generator is turned on, you need to turn on the corresponding channel to ensure valid waveform output.
- When the output is initiated, all the Arb settings and parameters cannot be configured.

10 Analyzer

DP2000 series power supply provides the Analyzer function for you to analyze the quality of output signals. Available analysis functions for the 3 channels include common analysis, pulse current analysis (only for CH1 and CH2), and data logging.

You can press the front-panel  or tap  > **Analyzer** to access the Analyzer main interface, as shown in the figure below. The label at the upper-left of the interface indicates the currently selected analysis function (common analysis/pulse current analysis). The four function keys at the right side allow you to easily configure the Analyzer settings, execute analysis, print screen, and control labels.

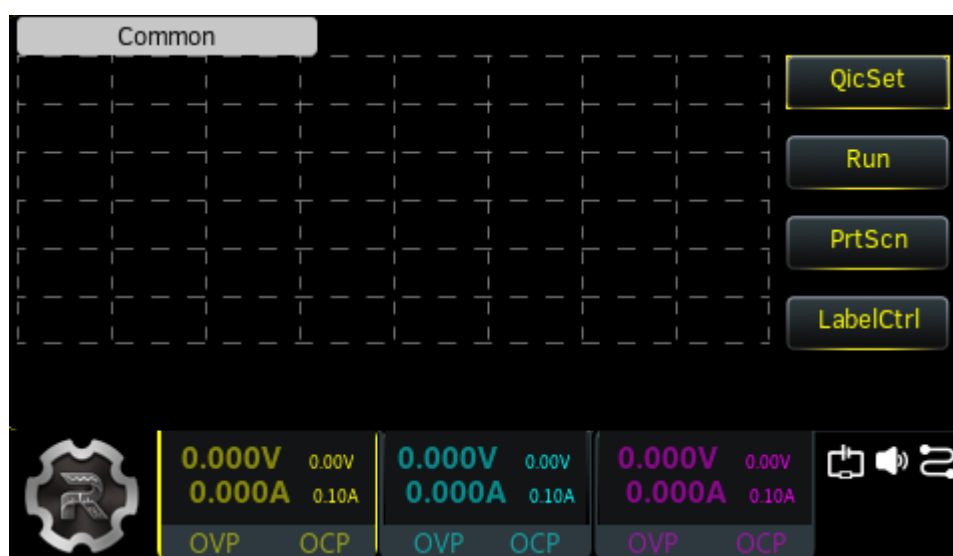

Figure 10.1 Analyzer Main Interface

10.1 Common Analysis

In the Analyzer main interface, tap **QicSet** to access the quick setup interface. Then tap **Common** to enter the common analysis setting interface, as shown in the figure below. In this interface, you can select the object to analyze and statistical method.

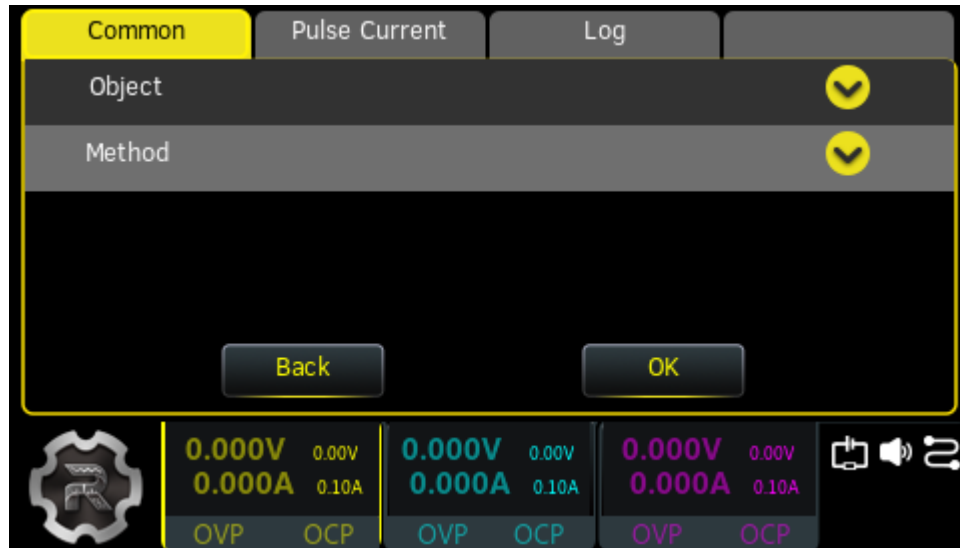

Figure 10.2 Common Analysis Setting Interface

10.1.1 Selecting Analysis Object

After entering the common analysis interface, you can tap **Object** to access the analysis object setting menu, as shown in the figure below. Select one to three items from the "Current", "Voltage", and "Power" items of CH1, CH2, and CH3.

Then tap **OK** to go back to the analyzer main interface. Tap **Run** and the instrument will execute analysis based on the your selections.

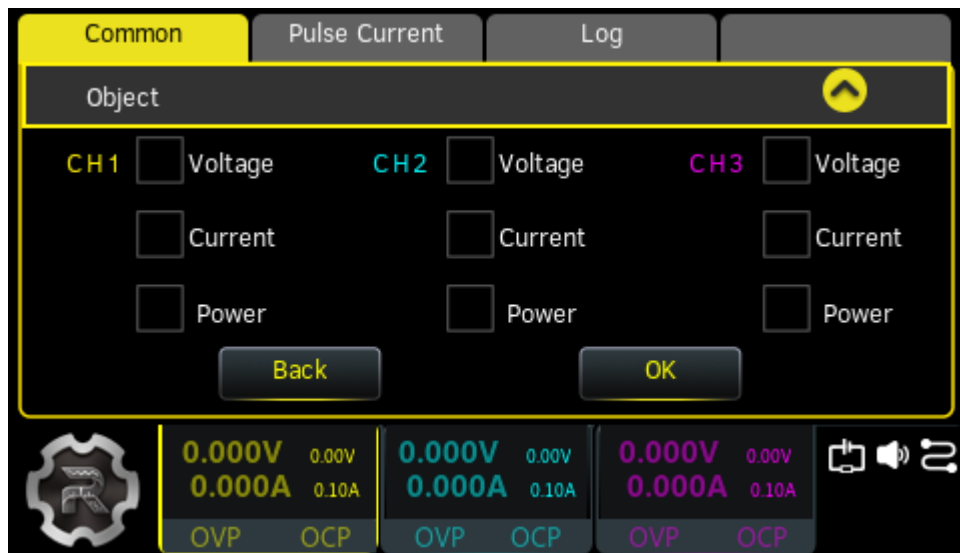

Figure 10.3 Analysis Object Setting Menu

10.1.2 Selecting Statistical Method

After entering the common analysis interface, tap **Method** to pop up the statistical method setting menu. You can select RT Plot or Trend Plot.

- **RT Plot**

It displays the analysis object currently selected in real-time plot. In RT Plot mode, the waveform of the collected signals slowly scrolls from right to left. The latest data is displayed on the screen.

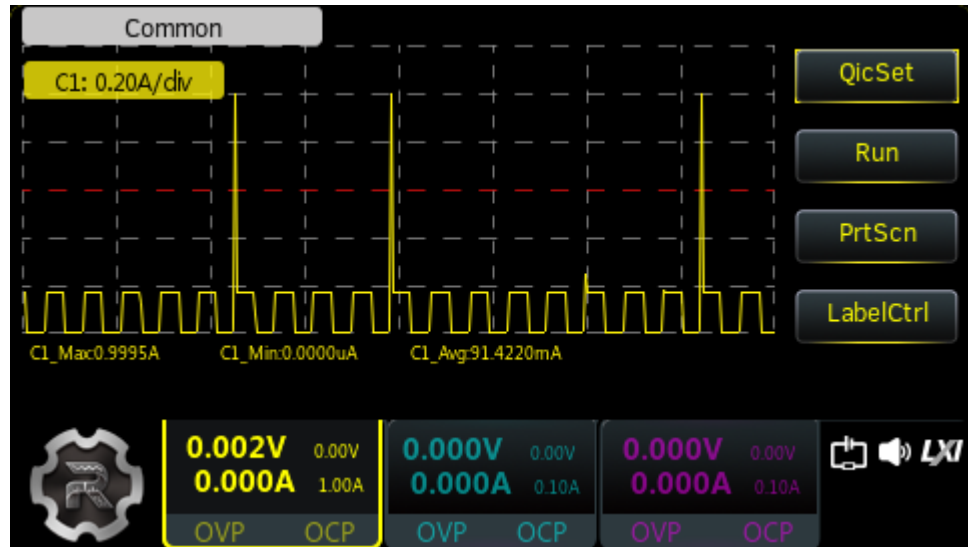

- **Trend Plot**

It displays the analysis object currently selected in trend plot. In Trend Plot mode, the waveform plot area is divided into two parts: the left displays trend waveform while the right displays real-time data. Real-time data will be drawn point by point. When the data is out of the screen, it will be compressed and displayed proportionally in the trend plot. Then, real-time data will be redrawn from left to right.

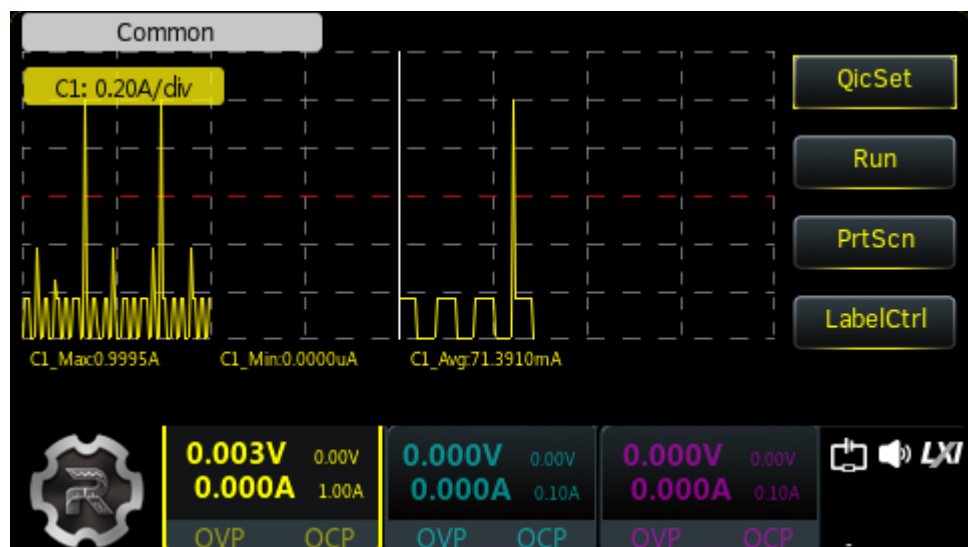

10.2 Pulse Current Analysis

The pulse current analysis function is only available for CH1 and CH2 of this series power supply. After entering the quick setup interface, you can tap **Pulse Current** to enter the pulse current analysis setting interface, as shown in the figure below.

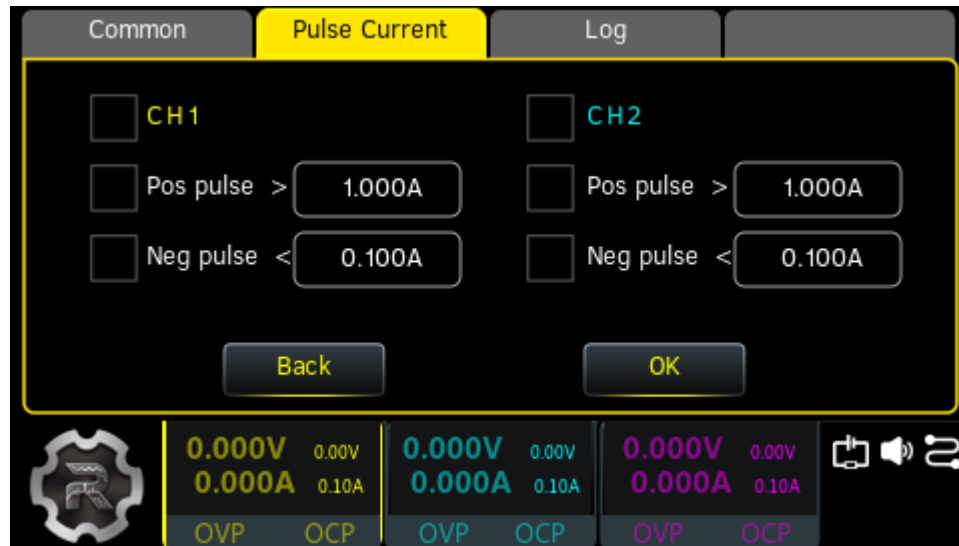

Figure 10.4 Pulse Current Analysis Setting Interface

1. First select the channel you want to analyze.
2. Tap **Pos pulse** or **Neg pulse** to select the pulse current to analyze.
 - Positive pulse: Select **Pos pulse**, and set the upper threshold level in the input field. In the analysis process, the Analyzer records the number of pulses above the threshold and the most recent pulse width beyond this upper threshold.
 - Negative pulse: Select **Neg pulse**, and set the lower threshold level in the input field. In the analysis process, the Analyzer records the number of pulses below the threshold and the most recent pulse width below this threshold.
3. Then tap **OK** to return to the Analyzer main interface. Tap **Run** and the instrument will execute analysis based on your selections. The analysis interface is shown in the figure below. The analysis results are at the lower part of the interface.

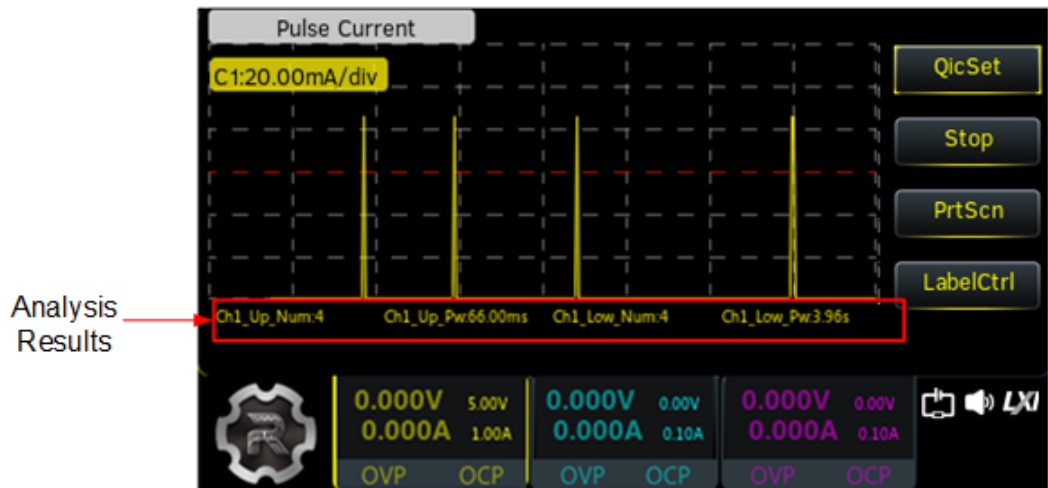

Figure 10.5 Pulse Current Analysis Interface

10.3 Data Logging

The data logging function allows you to record waveform data collected in real time. The data is stored to a *.ROF file in the predefined target folder.

After entering the quick setup interface, you can tap **Log** to enter the interface as shown in the figure below. You can enable/disable the data logging function and set the target location to save the data.



Figure 10.6 Log Setting Interface

Storage Path

Tap **Save to** input field to access the Store and Recall interface. Select the desired storage path and then tap **Save**. Set the filename in the pop-up filename input field. The data is stored to a file with .ROF extension.

**TIP**

You can store files in the instrument's internal memory or an external USB device. The maximum size of log file saved in internal memory is 20M. The size of the file saved in the external USB device depends on the memory size of the device.

Logger On/Off

Tap the **Logger** on/off toggle switch to turn on/off the logger.

- Select **ON** to enable the data logging function. When turning on the Analyzer (through tapping **Run** in the Analyzer main interface), the instrument stores the waveform data collected in real time at the current sample rate. The logging finishes as the analysis stops. The file is saved in the specified location.
- Select **OFF** to disable the data logging function. When the Analyzer is on, the system will not perform any data logging.

**TIP**

- If the storage location is not changed, the data logged at different times will be saved to the same file.
- Record at least 1 point to save the file.

10.4 Print Screen

In the analyzer main interface, you can tap **PrtScn** to capture and save the current screen. By default, the screen images are stored in internal memory of the instrument. If a USB storage device is detected, the images will be saved to the USB device under the target folder. A dialog window will pop up indicating the file location. The saved file is in .BMP format.

The first screen image is named "Analyzer0.BMP" by default. The number next to "Analyzer" in the name increments by 1 each time a new image is captured and saved under the current path. For example, the second screen image is named "Analyzer1.BMP" .

10.5 Label Control

Tap **label Control** in the Analyzer main interface to hide or display the labels of analysis objects.

11 Trigger

DP2000 series power supply supports trigger input and trigger output via the rear-panel Digital I/O interface.

- Trigger Input:

The data lines of the digital I/O interface receive external trigger signal. The source under control (namely the selected output channel) turns on/off the output or inverts the output state when the preset trigger condition is met.

- Trigger Output:

The data lines of the digital I/O interface output a high/low level signal when the control source (namely the selected output channel) turns on the output.

The 4 data lines of the digital I/O interface are mutually independent and can be used for trigger input or trigger output separately.

The digital port connections are shown in the figure below.

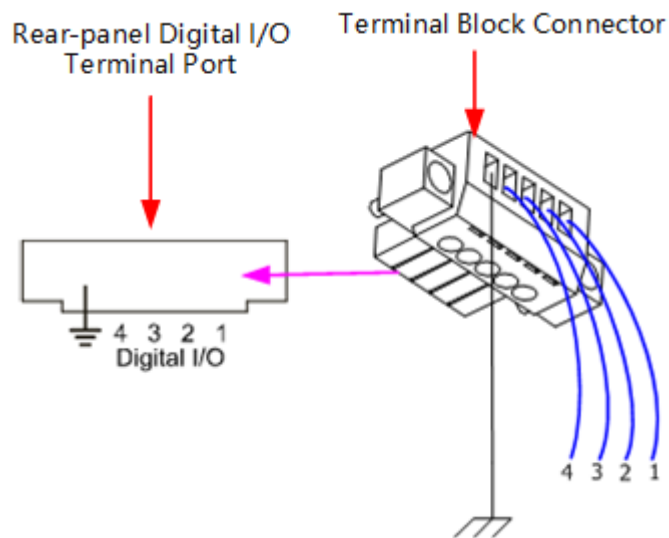



Figure 11.1 Digital Port Connections

Operation Procedures:

1. Connect the wires to the terminal block connector according to the figure above (pay attention to the corresponding relations).
2. Insert the terminal block connector into the digital I/O terminal port on the rear panel (pay attention to the corresponding relations).

Tap  > **Trigger** to access the trigger setting interface, as shown in the figure below. You can tap **Trigger Input** or **Trigger Output** to access the corresponding interface.

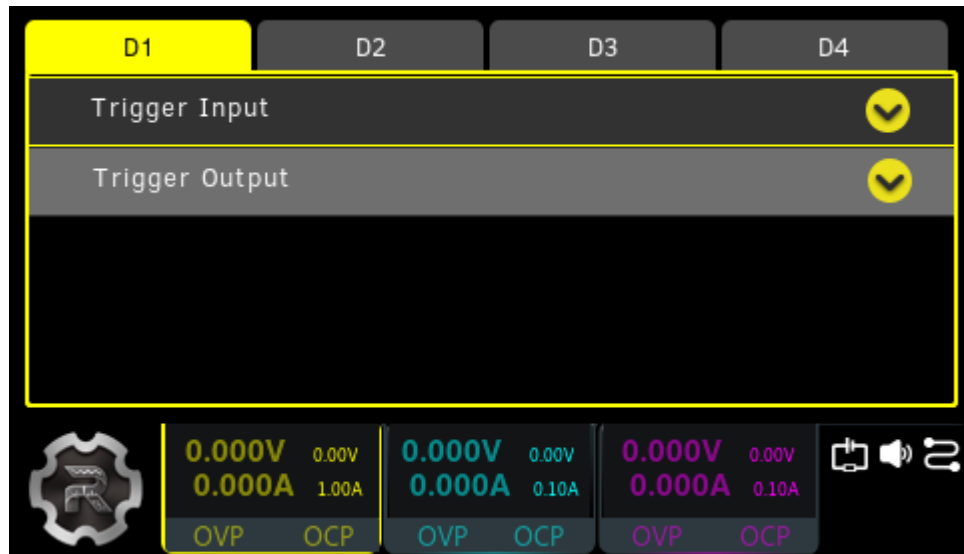

Figure 11.2 Trigger Setting Interface

11.1 Trigger Input

When the specified data line receives input signal that meets the current *Trigger Type*, the specified source under control will turn on/off the output, or toggle the output state according to the setting in *Output Response*.

Tap  > **Trigger** at the lower-left of the screen. Then select **Trigger Input** to open the trigger input setting interface, as is shown in the figure below.



Figure 11.3 Trigger Input Setting Interface

Data Line

Select a data line (D1, D2, D3, or D4) you wish to configure. The data line label is lit after selected. You can configure the trigger settings for the four data lines respectively.

Trigger Input On/Off

Tap the **TrigIn** on/off button to enable or disable the respective trigger input settings for the selected data line.

Source Under Control

In the **Channel** item, you can select one or more of CH1, CH2, and CH3 as the source under control by ticking the box.

Trigger Type

Tap the **TrigType** drop-down button to select to trigger on the rising edge, falling edge, high level, or low level of the input signal.



TIP

For the input signal, high level ranges from 2.5 V to 3.3 V, low level from 0 V to 0.8 V, and the noise tolerance is 0.4 V.

Output Response

Tap the **Response** drop-down menu to set the trigger response type to "OutOn", "OutOff" , or "OutFlip" .

- OutOn: Turns on the output of the channel currently selected as the source under control when the trigger condition is met.
- OutOff: Turns off the output of the channel currently selected as the source under control when the trigger condition is met.
- OutFlip: Toggles the channel output state. That is, turns off the channel when the current channel is on, or turns on the channel when the current channel is off.

11.2 Trigger Output

The specified data line outputs a high/low level signal when the control source turns on the output.

Tap  > **Trigger** and select **Trigger Output** to access the trigger output setting interface, as shown in the figure below.

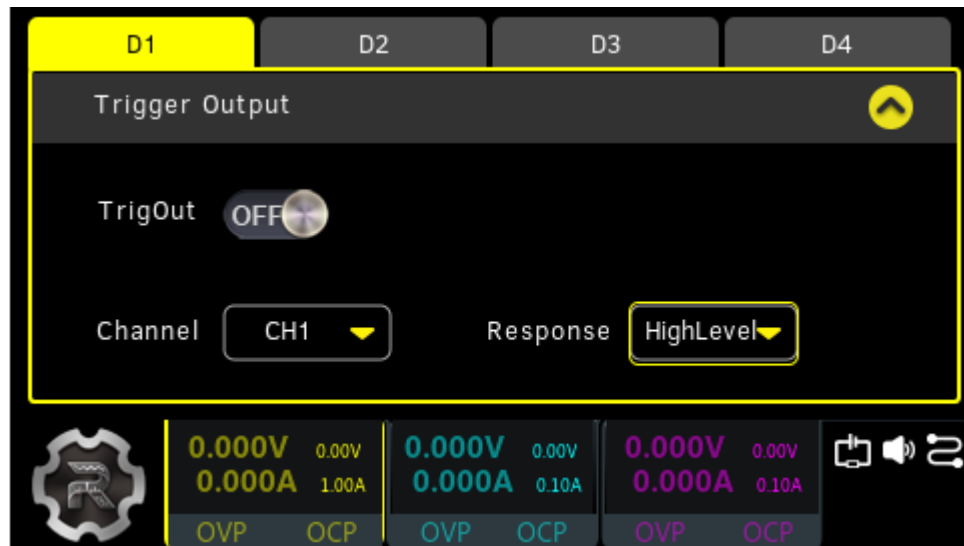

Figure 11.4 Trigger Output Setting Interface

Data Line

Select a data line (D1, D2, D3, or D4) you wish to configure. The data line label is lit after selected. You can configure the trigger settings for the four data lines respectively.

Trigger Output On/Off

Tap the **TrigOut** on/off button to enable or disable the respective trigger output settings for the selected data line.

Control Source

Tap the **Channel** drop-down button to select CH1, Ch2, or CH3 as the control source.

Output Response

Tap the **Response** drop-down button to set the trigger response type to "HighLevel" or "LowLevel" .

- High Level: The selected data line outputs 3.3 V high level when the control source is turned on.
- Low Level: The selected data line outputs low level signal (CMOS level) when the control source is turned on.

12 Store and Recall

You can store various types of files in internal or external memory, and recall the stored files when required. Besides, you can also copy, paste, or delete files of the specified type in internal or external memory.

This series power supply provides an internal non-volatile memory and two USB HOST interfaces (one on the front panel and the other on the rear panel), which can be used to connect USB storage devices for external storage. The internal memory is C disk, and the external memory is D disk and E disk.

TIP

The instrument only supports the flash memory USB storage device of FAT32 format.



Press the front-panel  or tap  > **Store** to enter the interface as shown in the figure below.

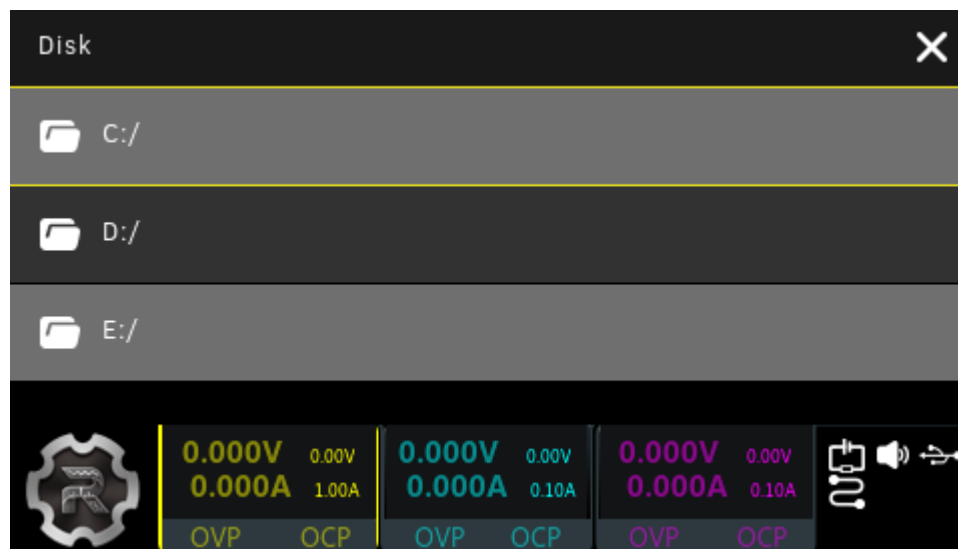

Figure 12.1 Disk Interface

- **C Disk**

Folders cannot be stored in C disk. The file types available for storage include state file (.RSF), log file (.ROF), Arb file (.RTF), bitmap file (.BMP), calibration file (.CLF), and option installation verification file (.LIC).

TIP

- Do not copy unsupported file type to C disk, or a prompt message "Filetype not supported." will be displayed.
- The C disk supports file locking. You can lock/unlock files via the SCPI command :MEMory:LOCK <name>,<bool>. A lock icon will appear at the upper-





right of the locked file which cannot be copied or deleted (but can be safe cleared). For more details about the SCPI commands and programming, please refer to the *Programming Guide* of the series.

- **D Disk and E Disk**



The D and E disks are available only when a USB storage device (FAT32 format, flash memory) is detected at the USB HOST port. You can save state file, log file, Arb file, and bitmap file to the USB storage device as well as copy the files in C disk to the USB storage device. The number of files that can be stored depends on the memory size of the USB storage device.

12.1 Select



First select a specified file. Tap the file and it is displayed as . Tapping the file again can unselect the file.

The series power supply allows you to select multiple files at once: tap  at the upper-right corner to select all files under the folder; tap  again to cancel the operation.

12.2 Save

1. Press the front-panel  or tap  > **Store** to open the disk interface and select the desired path.
2. Tap **Save** to pop up the filename setting interface, as is shown in the figure below.



3. Enter your desired filename in the "FileName" input field. Then tap  to complete the entry and save the file, or tap  to cancel the operation. This



instrument supports both Chinese input method (T9) and English input method (uppercase/lowercase). In the filename setting interface, you can do the following to select your desired input method.

- Tap “CH” key to switch to the Chinese input method.
- Tap “1#” key in the keypad to enter numbers or symbols.
- Tap “ABC” key to enter upper-case English letters or tap “abc” key to switch to the lower-case mode.

The save operation in the store/recall function is available only when the file is a “state file” .

- To save log file, please refer to *Data Logging*.
- To save Arb file, please refer to *Import and Export*.
- To save bitmap file, please refer to *Print Screen*.
- To save option installation verification file, please refer to *Option Settings*.



12.3 Read

1. Press the front-panel  or tap  > **Store** to access the disk interface. Enter the target directory to select the desired file.

The read operation is available only when the file is “state file” . To read Arb file, please refer to *Import and Export*.

2. Then tap **Read**, and the file currently selected will be read. After the file is successfully read, a prompt message is displayed. The instrument will load the system parameters in the state file and reset the instrument with the loaded instrument settings.

12.4 Delete



1. Press the front-panel  or tap  > **Store** to access the disk interface. Enter the target directory to select the file that you want to delete.
2. Tap **Delete**, and a prompt message “Delete selected files?” is displayed. Tap **Yes** to delete the file.

TIP

You can also click or tap **SafeClear** in the C disk to delete all files (including locked files) in it.





12.5 Copy and Paste

1. Press the front-panel  or tap  > **Store** to access the disk interface. Enter the target directory to select the desired file.
2. Tap **Copy** to copy the file currently selected.
3. Tap  at the upper-left side of the screen to go back to the disk interface. Select the directory to which you want to paste the file.
4. After entering the target folder, tap **Paste** to complete the paste operation. If the file already exists in the current folder, a prompt message “File exists.” will pop up.

You can copy files in the three disks to each other, except the following situations.

- You are not allowed to copy folders.
- You are not allowed to copy the file locked in C disk.
- C disk has 2GB memory size. When it is running out of space, a prompt message “Low disk space.” will be displayed.
- The file copied to C disk cannot be larger than 2MB.
- Unsupported file type cannot be copied to C disk.

13 Utility

You can press the front-panel  or tap  > **Utility** to enter the interface as shown in the figure below. You can configure system setting, output setting, interface parameter setting, and option setting.

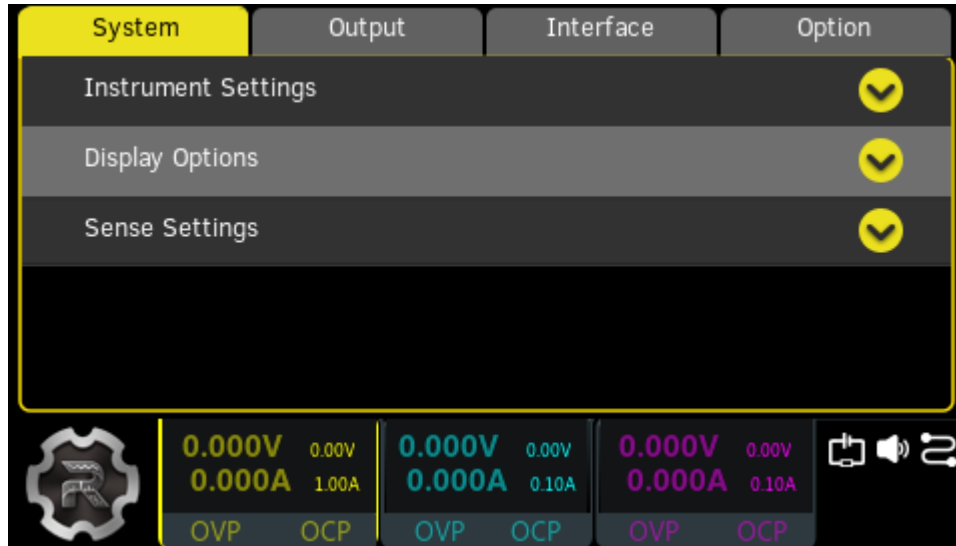



Figure 13.1 Utility Interface



- **System:** Configure system parameters, display, and so on.
- **Output:** Set track mode and output connections.
- **Interface:** Configure the LAN, RS232, and GPIB (optional), as well as view the USB information.
- **Option:** View the current option installation information and install the option.

13.1 System Settings

Press  > **System** or tap  > **Utility** > **System** to enter the system settings interface.

- **Instrument Settings**
Set the system parameters, such as Preset key, power-on settings, and beeper.
- **Display Options**
Set the brightness and system language.
- **Sense Settings**
Turn on/off the Sense function for the three channels respectively.

13.1.1 Instrument Settings

Press  > **System** > **Instrument Settings** or tap  > **Utility** > **System** > **Instrument Settings** to access the interface as shown in the figure below. The Instrument Settings interface allows you to configure the front-panel Preset key, beeper, and power-on settings.

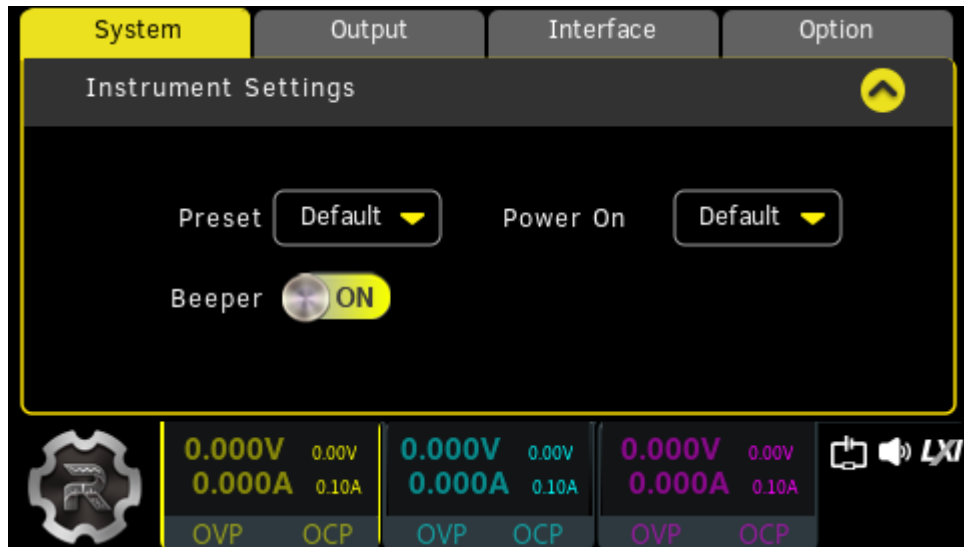

Figure 13.2 Instrument Settings Interface

Beeper

Tap **Beeper** switch to toggle between **ON** and **OFF** to enable or disable the beeper sound. When it is turned on, the click heard is enabled when the touch screen is used or the front-panel keys and knob are used.

Power-on Setting

You can tap the **Power On** drop-down button to select the state that will be loaded at power-up. This can be either “Default” or “Last” . The default setting is "Default" .

- **Default:** Uses the factory setting, except for the parameters that are not affected by factory reset.
- **Last:** Loads the system state at the last power-off.

Preset Key Function

Tap **Preset** to define the function of the front-panel “Preset” key. You can select

“Default” . Press  on the front panel and a prompt message “Restore the instrument to factory default settings?” is displayed. Tap **Yes** to restore to factory default.

Table 13.1 Factory Default Values

Channel Settings	
Voltage/Current Settings	CH1/CH2/CH3: 0 V/0.1 A
Voltage/Current Limit Settings	CH1: 33.6 V/3.3 A CH2: 33.6 V/3.3 A CH3: 6.3 V/11 A
OVP/OCP On/Off	CH1/CH2/CH3: OFF/OFF
Output On/Off	CH1/CH2/CH3: OFF
Arb	
Repetition Cycle	1
End State	Last
Run Mode	Continuous
Trigger Source	Manual
Triggered Channel	CH1
Group Number	0
Waveform Template	Sine
Object	Voltage
Constant Current	1 A
Max	1 V
Min	0 V
Groups	50
Interval	1 s
Period (Sine, Ramp, StairUp, StairDn, StairUpDn)	50 s
Invert	OFF
Positive Pulse Width	25 s
Symmetry	50%
Steps	25
Exp	10
Analyzer	
Display	Empty
Object	NA
Channel	NA
Method	RT Plot
Channel (Pulse Current Analysis)	NA
Positive/Negative Pulse	NA
Positive Pulse	1 A

Analyzer

Negative Pulse	0.1 A
Logger	OFF
Save Path	NA

Trigger**Trigger Input**

Trigger Input On/Off	OFF
Source Under Control	NA
Trigger Type	Rising edge
Output Response	Output off

Trigger Output

Trigger Output On/Off	OFF
Control Source	CH1
Output Response	High Level



Utility

Preset Key Function	Default
Power-on Setting	Default
Beeper	ON
Language	Chinese
Brightness	50%
Sense	CH1/CH2/CH3: OFF
Tracking	OFF
Safe Mode	ON
CH-Off Mode	0 V
Channel Connection	Independent
Sampling	Auto
Current Sampling Rate	3.75 kSPS
DHCP	ON
AUTO	ON
MANUAL	OFF
Bit Rate	9600
Data Bit	8
Parity	None
Stop Bit	1
GPIO Address	02

Store

Current Directory	C:/
-------------------	-----

13.1.2 Display Options

Press  > **System** > **Display Options** or tap  > **Utility** > **System** > **Display Options** to enter the interface as shown in the figure below.

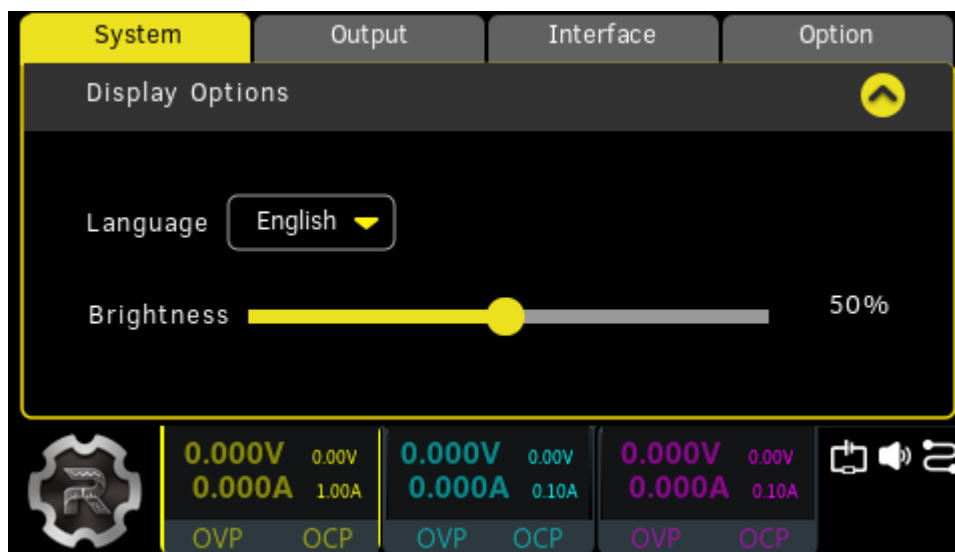

Figure 13.3 Display Options Interface

Language

The series power supply supports multiple languages. You can tap the **Language** drop-down button to select the system language.

Brightness

Use the slider of **Brightness** to adjust the brightness of the display. The range is from 1% to 100%, and the default is 50%. This setting is non-volatile; it will not be changed by factory reset.

13.1.3 Sense Settings

When the power supply outputs high range current, the voltage drop in the load leads cannot be ignored. To ensure correct voltage drop for the load, this series power supply provides the Sense (remote sensing) working mode for rear output terminals. This mode makes the voltage at the load identical to your voltage settings by monitoring the voltage at the load rather than at the output terminal which automatically compensates for the voltage drop in the load leads.

The following figures illustrate load connections using 2-wire sensing and remote sensing.

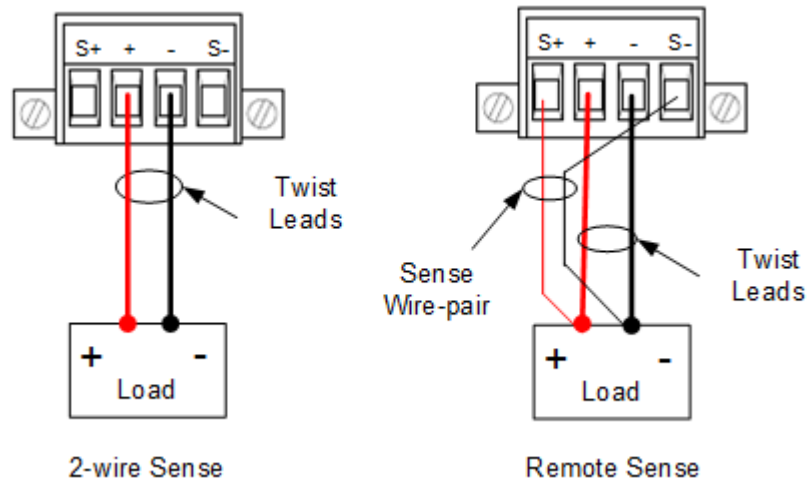



Figure 13.4 Rear Panel Connections

Operation Procedures:

1. Connect the load to the rear connectors correctly. Pay attention to the polarity while making connections.
2. Insert the connector into the rear output terminal of the instrument. Pay attention to the corresponding relations of the connector and the output terminal.
3. After that, press  > **System** > **Sense Settings** or tap  > **Utility** > **System** > **Sense Settings** to enter the interface as shown in the figure below.

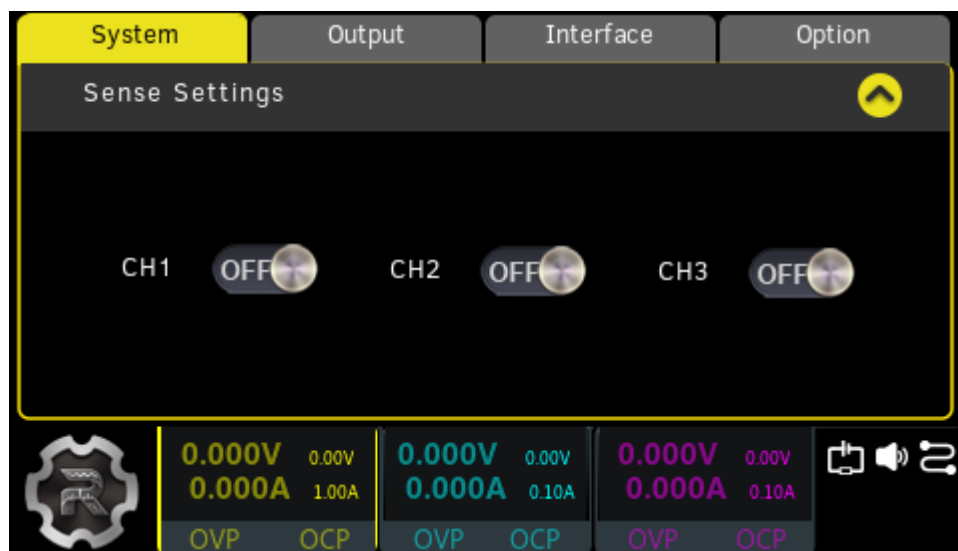

Figure 13.5 Sense Settings Interface

Select **ON** or **OFF** to activate the remote sensing for CH1/CH2/CH3. When the selected channel is "ON", the Sense function of the channel is enabled; when the selected channel is "OFF", the Sense function of the channel is disabled.





TIP

- When the output current is high, keep the load leads as short as possible and twist them for better outputs.
- It is recommended to use the twisted Sense wire-pair. Do not bundle them together with the load wires.

13.2 Output Settings

The Output Settings interface allows you to set the track mode, output off status, safe mode, sampling mode, current sampling rate, and channel connection status.

Press  > **Output** or tap  > **Utility** > **Output** to enter the interface as shown in the figure below.

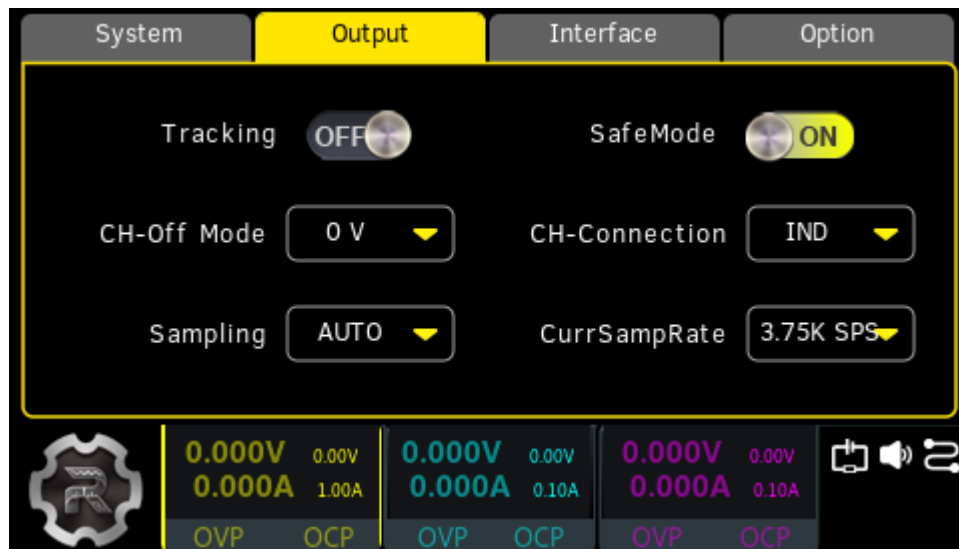

Figure 13.6 Output Settings Interface

13.2.1 Track Mode

The tracking function is usually used to provide symmetrical voltages needed by operational amplifiers and other circuits. For this series power supply, the tracking function is available for CH1 and CH2. You can enable or disable the track mode for those two channels.

Tap the **Tracking** on/off button to toggle between **ON** and **OFF** to enable or disable the track mode.

- **ON:** Enables the track mode. For the two channels (CH1 and CH2) that support this mode, changes made on one channel (voltage/current setting value, OVP/OCV level and on/off status) is applied to the other channel.
- **OFF:** Disables the track mode. For the two channels (CH1 and CH2) that support the track function, changes made on one channel will not affect the other.

**TIP**

The tracking function only tracks the voltage/current setting value. The actual output voltage/current will not be affected.

13.2.2 Safe Mode

Tap the **SafeMode** button to toggle between **ON** and **OFF** to enable or disable the safe mode.

- **ON:** Enables the safe mode. When CH1 and CH2 are connected in series (internal) and the sum of their voltages is higher than 60 V, a prompt message "Over safety voltage, sure set it?" will be displayed. Tap **Yes** to ignore the message or tap **No** to prevent the output voltage from exceeding 60 V.
- **OFF:** Disables the safe mode. You are free to set the voltage.

**WARNING**

When the output voltage exceeds 60 V in series connection, please do not touch the output terminals.

13.2.3 Sampling Mode

DP2000 series power supply provides three current sampling modes for CH1 and CH2. You can select "High Curr" , "Low Curr" , or "AUTO" . The default setting is "AUTO" .

- **AUTO:** When the power supply outputs current higher than or equal to 11 mA, it uses the high range current mode; when the power supply outputs current lower than 11 mA, it automatically switches to the low range current measurement mode.
- **High Curr:** The power supply uses the high range current mode.
- **Low Curr:** The maximum current that can be programmed is 0.5 A and the maximum current that can be read is 11 mA. When 11 mA is reached, the output current is displayed as "-.----" in the interface. When the power supply outputs current within 11 mA, it uses the low range current mode.

**TIP**

- The three sampling modes are available for CH1 and CH2 only. CH3 has no low range current sampling mode.
- When the instrument operates in parallel mode (internal), the sampling mode is fixed to "High Curr". If you want to use external parallel connection, you need to set the current sampling mode to high current mode manually.

13.2.4 Output Connection

This series power supply supports internal series or parallel connection for CH1 and CH2. Tap the **CH-Connection** drop-down button to select "Series" , "Parallel" , or "IND" to control the channel connection state.

- When "IND" is selected, CH1 and CH2 are independent of each other.
- When "Series" is selected, CH1 and CH2 are connected in series. The output voltage of CH1 is the sum of both CH1 and CH2 voltages, but CH2 is no longer working. For connections in internal series mode, please refer to *Series Connections*.
- When "Parallel" is selected, CH1 and CH2 are connected in parallel. The output current of CH1 is the sum of both CH1 and CH2 currents, but CH2 is no longer working. For connections in internal parallel mode, please refer to *Parallel Connections*.

**TIP**

In internal series/parallel connections, CH1 and CH2 always have identical voltage and current setting value.

13.2.5 Output Off Mode

Tap the **CH-Off Mode** drop-down menu to select the output state when channels are off. Available selections include "0 V" , "IMM" , and "Delay."

- **0 V:** Outputs 0 V voltage when channels are off.
- **IMM:** Clears the circuit immediately and turn off outputs when channels are off.
- **Delay:** Uses the turn-off delay when channels are off.

**TIP**

When "IMM" is selected, the voltage fall time is not guaranteed.

13.2.6 Current Sampling Rate



DP2000 series power supply provides three preset current sampling rate options for CH1 and CH2.

Tap **CurrSampRate** drop-down button to select 3.75K SPS, 7.5K SPS, or 29 SPS.

13.3 Interface Settings

DP2000 series supports remote interface communication over interfaces including USB, LAN, RS232, and GPIB (optional). RS232 and GPIB share the same physical port. You can control the instrument remotely via those interfaces.

Before using the LAN, RS232, or GPIB interface, please first set their parameters.

Press  > **Interface** or tap  > **Utility** > **Interface** to enter the interface and set the I/O parameters for remote operations.

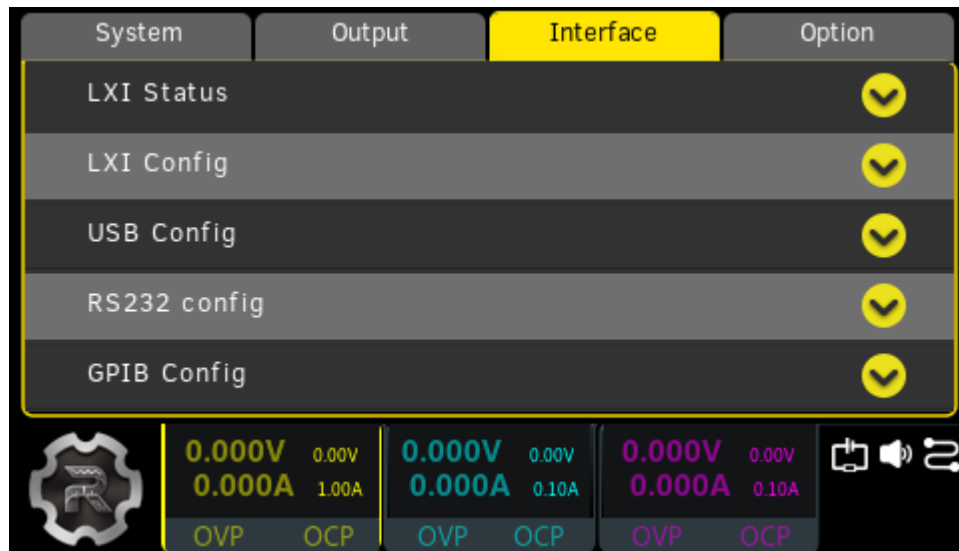

Figure 13.7 Interface Settings

13.3.1 LXI Status

Before using the LAN interface, please use the network cable to connect the instrument to your PC or to the network of the PC.

In the Interface Settings menu, tap **LXI Status** to access the interface as shown in the figure below. You can tap **LXI Status** again to collapse the current menu to revert to the Interface Settings menu.

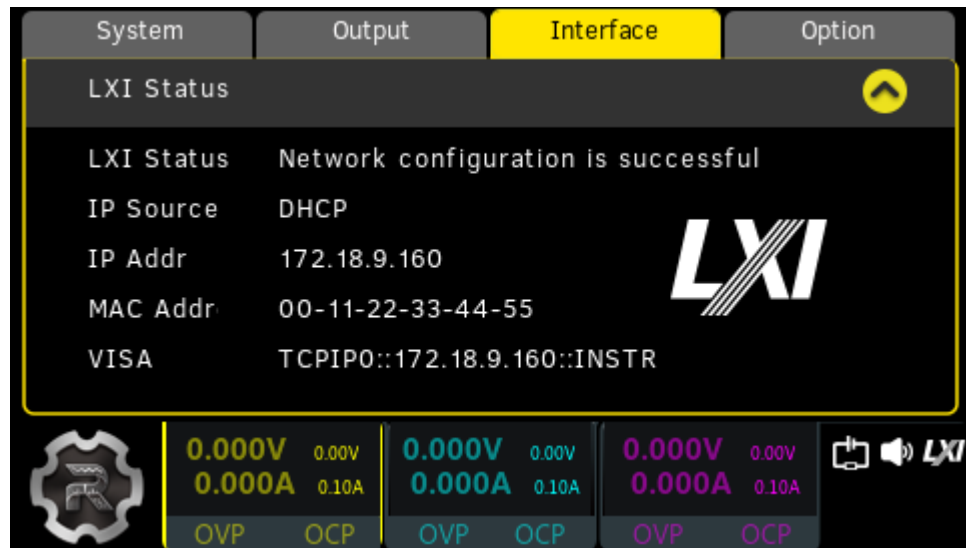

Figure 13.8 LXI Status Interface

The interface displays the network status, IP source, IP address, MAC address, and VISA.

- **LXI Status**

- Network access
- Network is not connected
- No network adapter
- Network initialization process
- Network configuration is successful
- Failed to obtain IP from DHCP server
- The IP assigned from DHCP is lost
- IP address conflict
- Invalid IP address
- DNS service detection success

- **IP Source**

It displays the IP configuration information: IP not obtained, DHCP, or AUTO. You can set the IP source in *LXI Setting* interface.

- **IP address**

It displays the IP address of the instrument.

- **MAC address**

It displays the MAC address of the instrument.

The Media Access Control (MAC) address, also called the hardware address, is used to define the location of the network device. For a power supply, the MAC address is always unique. When attributing IP address for the instrument, the MAC address is usually used to identify the instrument. The MAC address (48 bits, namely 6 bytes) is usually expressed in hexadecimal form, for example, 00-2A-A0-AA-E0-56.

- **VISA**

Virtual Instrument Software Architecture (VISA), an advanced application programming interface developed by National Instrument (NI), is used to communicate with various instrument buses. It uses the same method to communicate with the instrument regardless of the type of the instrument interface (GPIB, USB, LAN/Ethernet, or RS232). The instrument communicating with it via the GPIB, USB, LAN/Ethernet, or RS232 interface is called "Resource".

VISA descriptor is the resource name and describes the accurate name and location of the VISA resource. If the LAN interface is currently used to communicate with the instrument, the VISA descriptor is TCPIP::172.18.8.41::INSTR.

13.3.2 LXI Setting

In the Interface Settings menu, tap **LXI Config** to access the menu as shown in the figure below. You can tap **LXI Config** again to collapse the current menu to revert to the Interface Settings menu.

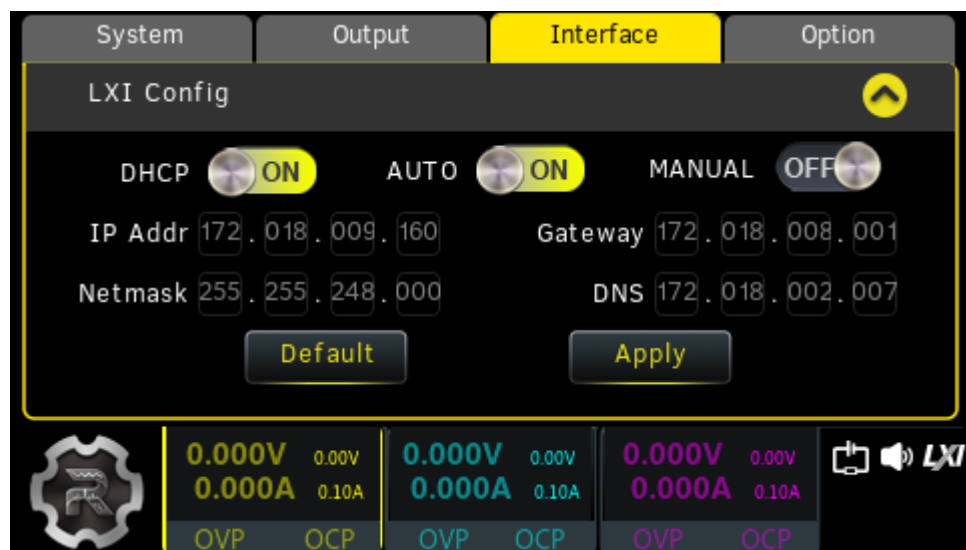

Figure 13.9 LXI Settings Menu

- **IP Configuration**

The TCP/IP address information for the instrument can be obtained in different ways, including DHCP, Auto IP, and Manual IP. You can tap the **DHCP, AUTO**, or **MANUAL** on/off switch to enable or disable the configuration. When **ON** is selected, the corresponding configuration mode is enabled. When **OFF** is selected, the corresponding configuration mode is disabled.

- **DHCP:** The Dynamic Host Configuration Protocol (DHCP) can automatically assign a dynamic IP address to the instrument from a DHCP server. By default, the instrument is configured to use DHCP.
- **Auto IP:** When "AUTO" is "ON" , it obtains the IP address (169.254.0.1 to 169.254.255.254) and subnet mask (255.255.0.0) depending on the current network configuration.
- **Manual IP:** When "MANUAL" is "ON" , you need to set the network parameters (such as IP address) manually.



TIP

- When all the three configuration modes are set to "ON", the priority of parameter configuration is "DHCP", "Auto IP", and "Manual IP". Therefore, to set the address manually, DHCP and Auto IP should be set to "OFF".
- They cannot be "OFF" at the same time.

- **IP Address**

Contact your network administrator for a valid IP address and set the address manually. The format of the IP address is nnn.nnn.nnn.nnn; wherein, the first nnn ranges from 1 to 223 (excluding 127), and the other three range from 0 to 255.

Enter the desired IP address using the front-panel parameter input area or the virtual keypad. This setting is non-volatile. The instrument will load your IP address automatically at the next power-on if "DHCP" and "Auto IP" are set to "OFF".

- **Gateway**

Contact your network administrator for a valid gateway address and set the default gateway manually. The format of the address is nnn.nnn.nnn.nnn; wherein, the first nnn ranges from 1 to 223 (excluding 127), and the other three range from 0 to 255.

Enter the desired gateway address using the front-panel parameter input area or the virtual keypad. This setting is non-volatile. The instrument will load your gateway address automatically at the next power-on if "DHCP" and "Auto IP" are set to "OFF".

- **Subnet Mask**

Contact your network administrator for a valid subnet mask and set it manually. The format of the subnet mask address is nnn.nnn.nnn.nnn; wherein, the range of the nnn is from 0 to 255.

Enter the desired subnet mask using the front-panel parameter input area or the virtual keypad. This setting is non-volatile. The instrument will load your subnet mask automatically at the next power-on if "DHCP" and "Auto IP" are set to "OFF".

- **DNS**

Contact your network administrator for a valid DNS address and set the address manually. The format of the DNS address is nnn.nnn.nnn.nnn; wherein, the first nnn ranges from 1 to 223 (excluding 127), and the other three range from 0 to 255.

Enter the desired DNS address using the front-panel parameter input area or the virtual keypad. This setting is non-volatile. The instrument will load your DNS address automatically at the next power-on if "DHCP" and "Auto IP" are set to "OFF".

- **Default Settings**

Tap **Default** and a prompt message "Restore to default network settings" is displayed. This operation enables DHCP and Auto IP and disables Manual IP.

- **Apply**

Tap **Apply** to apply the current settings and revert to the Interface Settings menu.

TIP

Note that you must tap **Apply** to save and apply the network settings.



13.3.3 RS232 Setting

Connect the RS232 interface to your PC or data terminal equipment (DTE) using RS232 cable and set the interface parameters (baud rate, parity bit, etc.) that match the PC or terminal equipment. Then, you can control the instrument remotely.

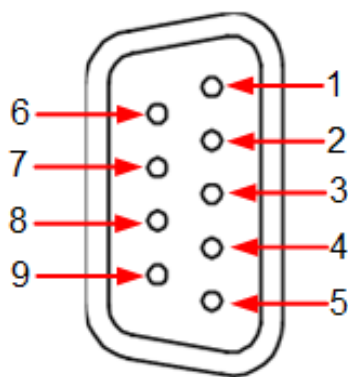

Figure 13.10 RS232 Interface

Table 13.2 RS232 Pin Definition

Pin	Name	Definition
1	DCD	Data Carrier Detect
2	TXD	Transmitted Data
3	RXD	Received Data
4	DTR	Data Terminal Ready
5	SGND	Signal Ground
6	DSR	Data Set Ready
7	CTS	Clear To Send
8	RTS	Request To Send
9	RI	Ring Indicator

In the Interface Settings menu, tap **RS232 Config** to access the menu as shown in the figure below. You can tap **RS232 Config** again to collapse the current menu to revert to the Interface Settings menu.

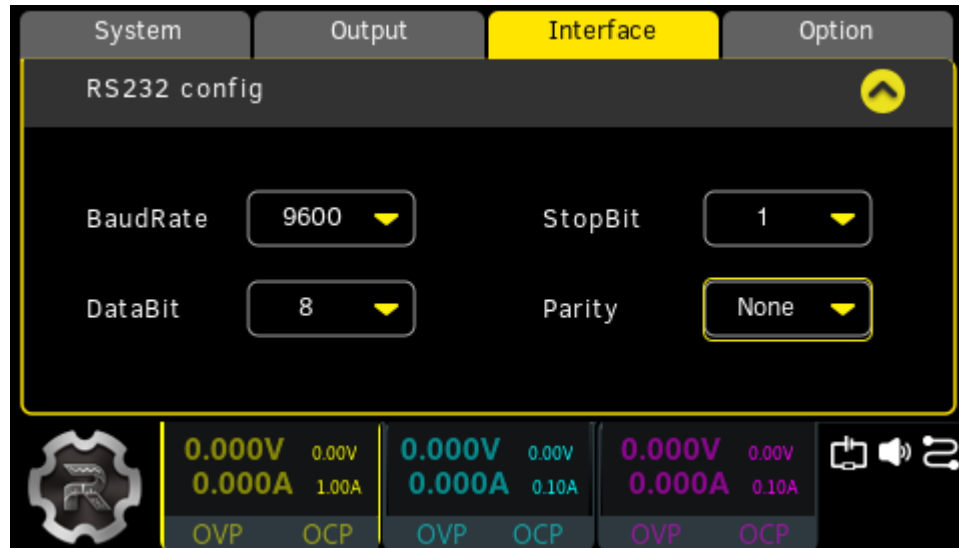

Figure 13.11 RS232 Configuration Interface

- Tap the **BaudRate** drop-down button to select the desired baud rate from 9600, 19200, 38400, 57600, and 115200. The unit is Baud.
- Tap the **StopBit** drop-down button to select 1 or 2.
- Tap the **DataBit** drop-down button to select 7 or 8.
- Tap the **Parity** drop-down button to select the parity check from “None” , “Odd” , and “Even” .

13.3.4 USB Configuration

In the Interface Settings menu, tap **USB Config** to enter the interface as shown in the figure below. The interface displays the USB information.

You can tap **USB Config** again to collapse the current menu to revert to the Interface Settings menu.

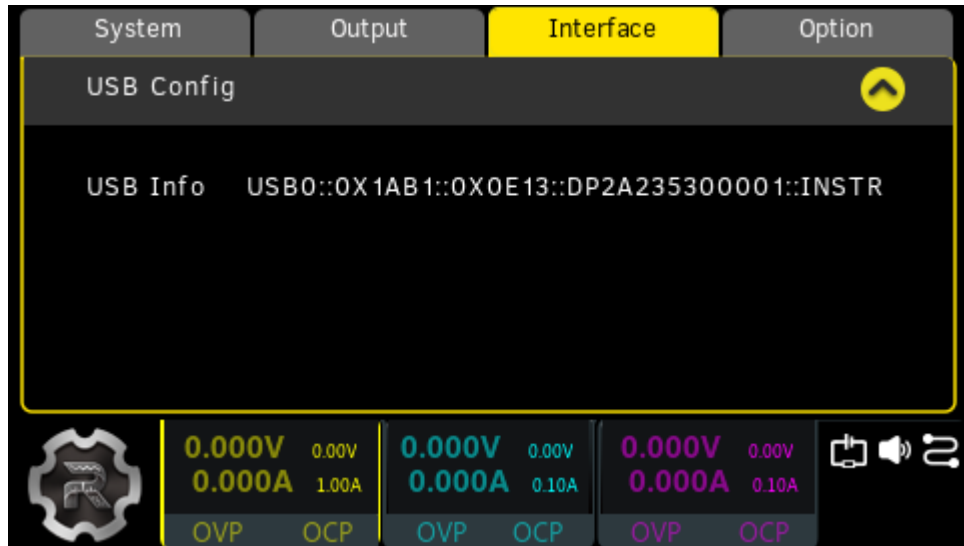

Figure 13.12 USB Configuration Interface

13.3.5 GPIB Configuration

Before using the GPIB interface, please first install the optional GPIB interface and then use a GPIB cable to connect the instrument and PC. In the Interface Settings menu, tap **GPIB Config** to access the menu as shown in the figure below. You can tap **GPIB Config** again to collapse the current menu to revert to the Interface Settings menu.

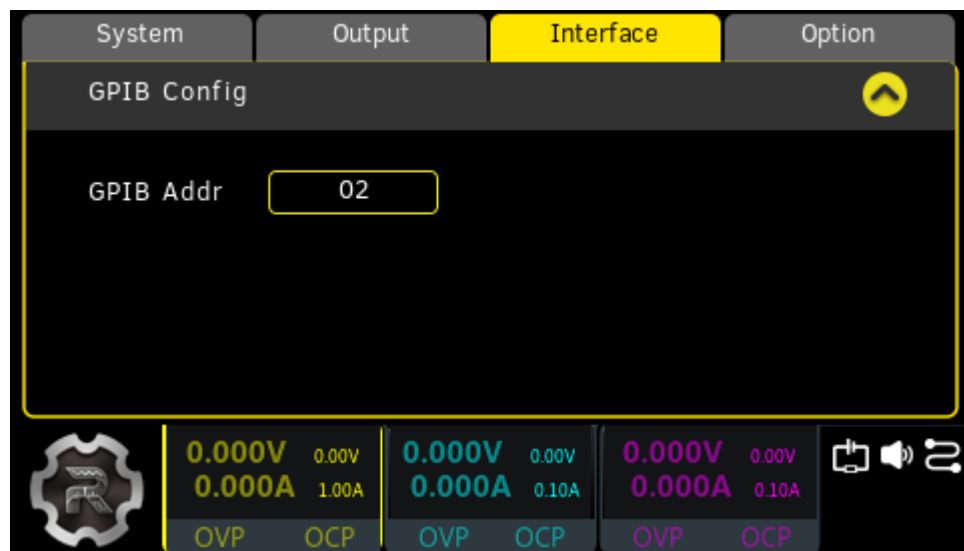

Figure 13.13 GPIB Configuration Interface

Tap the **GPIB Addr** input field and enter the desired GPIB address using the front-panel parameter input area or pop-up virtual keypad. The value can be any integer ranging from 0 to 30, and the default is 2. This setting is non-volatile; it will not be changed by factory reset.



**NOTE**

GPIB and RS232 share a physical port. Those two interfaces cannot be used concurrently.

13.4 Option Settings

This series power supply provides multiple options to fulfill your measurement requirements. If you need any of these options, please order the option according to the Order No. available in [Appendix A: Accessories and Options](#), and then install it by referring to this section. Besides, you can also view the options currently installed on the instrument or activate the newly purchased option.

View the Installed Option

Press  > **Option** or tap  > **Utility** > **Option** to enter the interface as shown in the figure below. You can view the installation information of all options in the interface.

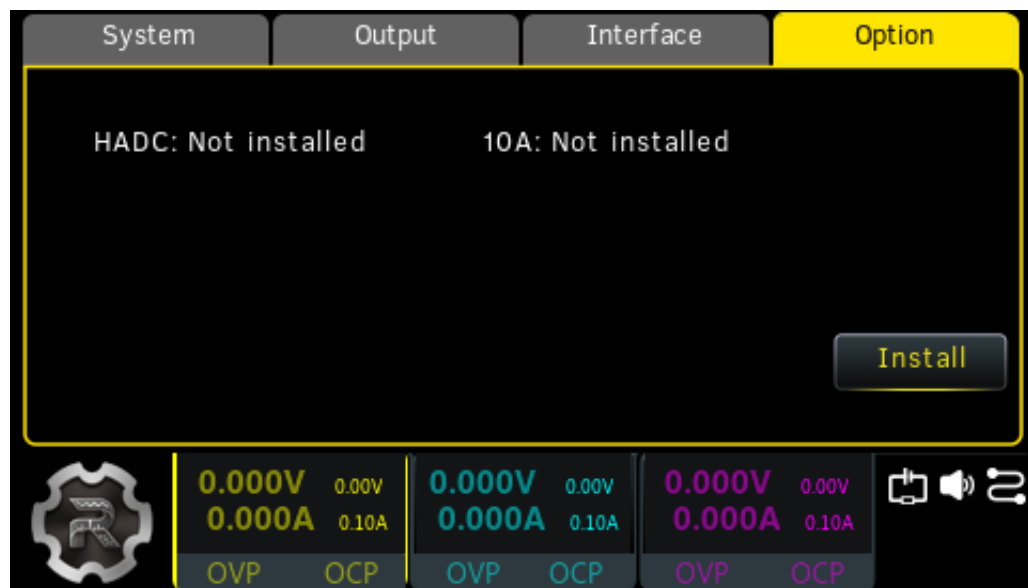



Figure 13.14 Option Settings Interface



Install the option

The option license is a string of fixed characters. The option file should be in specific format, with the file extension “.lic” . After you purchase an option, you will obtain a key (used for obtaining the desired option license). Please install the option following the steps below.

1. Obtain an option license

- a. Log in to the RIGOL official website (<http://www.rigol.com>), and click **SERVICE CENTRE** > **License Activation** to enter the software license registration interface.
- b. In the software license registration interface, enter the correct key, serial number (tap  > **Help** > **About** to obtain the serial number), and verification code. Then click **Generate** to obtain the option license file download link. If you need to use the file, please click the link to download the file to the root directory of the USB storage device.

2. Install the option



- a. Connect the USB storage device to the instrument. Press the front-panel  or tap  > **Store** to enter the disk interface. You can also tap **Install** in the option settings interface to access the disk interface.
- b. Select the desired file and tap **Read** to install the option.
- c. After installation, a prompt message "Option activated successfully" is displayed. After the option has been installed, it is recommended to restart the instrument.



TIP

- During the installation process, you are not allowed to power off the instrument or unplug the USB storage device.
- You can send SCPI commands to install options (please refer to *DP2000 Programming Guide*). Installing options by entering the license code manually is not supported.

14 Locking/Unlocking the Front Panel

To avoid any adverse effect caused by misoperation, you can long press the front-panel  to lock the touch screen. After the touch screen is locked, a lock icon  appears in the status area at the lower-right of the screen. You can long press  again to disable the touch lock.

You can also send SCPI commands to lock the display or front-panel keys.



Command Description

:SYSTem:TLOCK {ON|OFF|0|1} /*Enables or disables the touch lock.*/*

:SYSTem:TLOCK? /*Queries whether the display is locked.*/*

:SYSTem:KLOCK:STATe {ON|OFF|0|1} /*Enables or disables the remote lock mode.*/*

:SYSTem:TLOCK? /*Queries whether the remote lock is enabled.*/*

In remote lock mode, all front-panel keys are disabled except for the output on/off keys , all output on/off key , and the power switch key . At this point, you can press the output on/off key only to disable channel output.

Three Methods to Lock/Unlock the Keys Using SCPI Commands

- **Edit a command file that meets the following requirements and store it to a USB device; read this file in the instrument to lock or unlock the specified key.**

The content and format requirements of the command file are as follows.

- The filename suffix must be ".scpi".
- The filename cannot be longer than 20 characters.
- Content requirements:

The first line: the command used to lock or unlock the specified key.

The second line: blank (cannot be omitted).

TIP



The command file can contain multiple lines (for example, N lines). The first N-1 lines are the commands used to lock or unlock the specified keys and the Nth line is blank. At this point, you can execute locking /unlocking operations N-1 times by reading the file in the instrument.

Operation Procedures:



1. Edit a command file that meets the above requirements and store it to a USB storage device.

2. Start the instrument and insert the USB storage device. Press the front-panel

 or tap  > **Store** to open the store and recall interface.

3. In that interface, read the command file according to *Store and Recall*.

- **Send command via Ultra Sigma to lock or unlock the specified key**
 - Set up communication between the instrument and PC.
 - Run Ultra Sigma and search for the instrument resources.
 - Open the remote command control panel to send commands.
- **Program and send command to lock or unlock the specified key.**
 - Set up communication between the instrument and PC.
 - Use a programming language (e.g. LabVIEW, C#) to program and send command.

15 Remote Control

The instrument can be remotely controlled by the following three methods:

- **User-defined Programming**

You can program and control the instrument by using the SCPI (Standard Commands for Programmable Instruments) commands. For details about the SCPI commands and programming, please refer to the *Programming Guide* of the series.

- **PC Software**

You can use the PC software to send commands to control the instrument remotely. Ultra Sigma of RIGOL is recommended. You can log in to RIGOL official website (<http://www.rigol.com>) to download the software.

Operation Procedures:

- Set up communication between the instrument and PC.
- Run Ultra Sigma and search for the instrument resources.
- Open the remote command control panel to send commands.

- **Web Control**

This instrument supports Web Control. When connected to the network, the Web Control will display the real-time interface displayed on the instrument screen. Through the Web Control method, you can migrant the device control to the control terminals (e.g. PC, Mobile, iPad, and other smart terminals) to realize remote control of the instrument. When you first log in to the Web Control, the user name is "admin" and password is "rigol".

This instrument can be connected to the PC via the USB, LAN, RS232, or GPIB interface to set up communication and realize remote control through the PC. The remote control is realized via SCPI commands.

This chapter will illustrate how to use the RIGOL Ultra Sigma software to remotely control the instrument via various interfaces. Note: When communicating with the PC via GPIB, the instrument does not support large data transmission operation such as screen shot.

TIP

Before setting up communication, please turn off the instrument to avoid causing damage to the communication interfaces.



15.1 Remote Control via USB

1. Connect the device

Use the USB cable to connect the rear-panel USB DEVICE interface of the instrument to the USB HOST interface of the PC.

2. Search for the device resource

Start up Ultra Sigma and the software will automatically search for the resource currently connected to the PC via the USB interface. You can also click **USB-TMC** to search for the resource.

3. View the device resource

The resources found will appear under the "RIGOL Online Resource" directory, and the model number and USB interface information of the instrument will also be displayed.

4. Control the instrument remotely

Right-click the device resource name and select "SCPI Panel Control" to open the remotely command control panel. Then you can send commands and read data through the panel. For details about the SCPI commands and programming, refer to the Programming Guide of this instrument.

15.2 Remote Control via LAN

1. Connect the device

Use the network cable to connect the instrument to your local area network (LAN).

2. Configure network parameters

Configure the network parameters of the instrument according to *Interface Settings*.

3. Search for the device resource

Start up Ultra Sigma and click **LAN** to open the window as shown in the figure below. Click **Search** and the software searches for the instrument resources currently connected to the LAN. The resources found are displayed at the right section of the window as shown in the figure below. Click **OK** to add it.

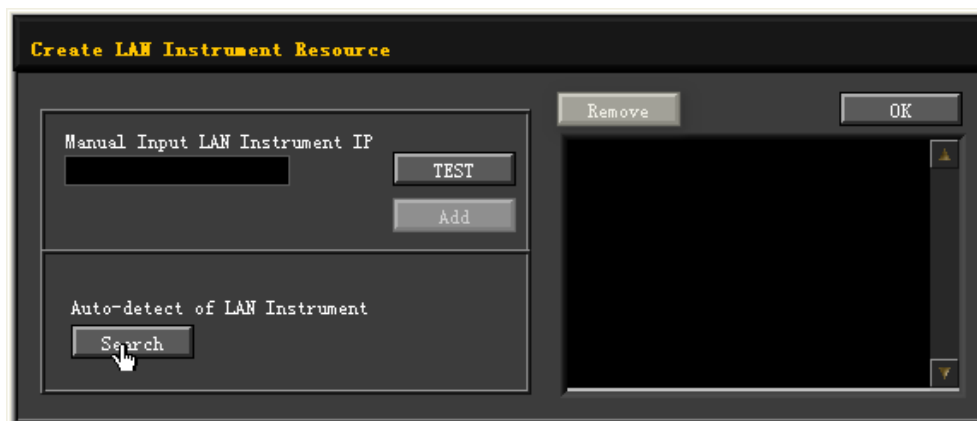

Besides, you can input the IP address of the instrument manually into the text field under "Manual Input LAN Instrument IP", and then click **TEST**. If the instrument passes the test, click **ADD** to add the instrument to the LAN instrument resource list at the right section of the window; if the instrument fails the test, please check whether the IP address that you input is correct, or use the auto search method to add the instrument resource.

4. View the device resource

The resources found will appear under the "RIGOL Online Resource" directory.

5. Control the instrument remotely

Right-click the device resource name and select "SCPI Panel Control" to open the remote command control panel. Then you can send commands and read data through the panel.

6. Load LXI webpage

As this instrument conforms to LXI CORE 2011 DEVICE standards, you can load LXI webpage through Ultra Sigma (right-click the instrument resource name and select "LXI-Web"). Various important information about the instrument (including the model, manufacturer, serial number, description, MAC address, and IP address) will be displayed on the webpage. You can also directly input the IP address of the instrument in the address bar of the PC browser to load the LXI webpage.

15.3 Remote Control via GPIB (Optional)

1. Connect the device

After installing the optional GPIB interface, use the GPIB cable to connect the instrument to the PC to realize remote control.

2. Install the driver of GPIB card

Correctly install the driver of the GPIB card which has been connected to the PC.

3. Set the GPIB address

Please refer to *GPIB Configuration*.

4. Search for the device resource

Start up and click **GPIB** to pop up *Figure 15.1* . Click **Search** and the software searches for the instrument resource currently connected to the PC via the GPIB interface. The resource found is displayed at the right side of the window, as shown in *Figure 15.2* . Click **OK** to add it.



Figure 15.1 Search for the Available Device



Figure 15.2 Confirm the Available Device

5. View the device resource

Click **OK** to go back to the main interface of Ultra Sigma. The searched instrument resource will be displayed under the directory of "RIGOL Online Resource".

6. Control the instrument remotely

Right-click the device resource name and select "SCPI Panel Control" to open the remote command control panel. Then you can send commands and read data through the panel.

15.4 Remote Control via RS232

1. Connect the device

Use the RS232 cable you connect the instrument to to your PC.

2. Configure network parameters

Configure the RS232 parameters according to *RS232 Setting*.

3. Search for the device resource

Start up Ultra Sigma and click **RS232** to open the window as shown in the figure below. Select the instrument resource name that you want to add and set the corresponding parameters (such as baud rate and check bit) according to the current RS232 parameter setting of the instrument (Note: \r\n must be selected as the End Mark).



After the setting, click **TEST** and the dialog box as shown in figure is displayed. Click **OK**; at this point, **Add** is available. Click **Add** and the instrument resource name currently selected will be displayed at the right of the window. Click **OK** to add the instrument resource.

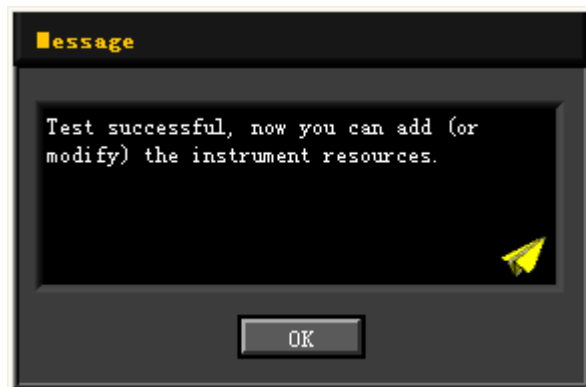

CAUTION

If the test fails, please check whether the instrument can communicate normally with the PC via the RS232 cable and whether the RS232 parameters of the software match with the current settings of the instrument.

4. View the device resource

The resources found will appear under the "RIGOL Online Resource" directory.

5. Control the instrument remotely

Right-click the device resource name and select “SCPI Panel Control” to open the remote command control panel. Then you can send commands and read data through the panel.

16 Troubleshooting

The following failures may occur during the use of the instrument. Please first try to handle the problem according to the following methods; if the problem remains unsolved, please contact RIGOL and provide the device information of your

instrument (by tapping  > **Help** > **About**).

1. The instrument does not start.

- a. Check whether the power cord is correctly connected.
- b. Check whether the power switch on the front panel is turned on.
- c. Unplug the power cord, and check whether the voltage selector is at the proper scale, whether the fuse specification is correct and the fuse is in good condition.

To replace the fuse, please refer to *Replacing the Fuse*.

- d. If the problem still persists, please contact RIGOL.

2. The constant voltage output is abnormal.

- a. Check whether the maximum output power of the selected meets the load requirement. If the load requirement is met, go to the next step.
- b. Check whether the cable connecting the load and power supply is short-circuited and whether it is in good contact.
- c. Check whether the load works normally.
- d. Check whether the current setting value of this scale is proper; if it is too low, increase the current setting value properly.
- e. If the problem still persists, please contact RIGOL.

3. The constant current output is abnormal.

- a. Check whether the maximum output power of the selected meets the load requirement. If the load requirement is met, go to the next step.
- b. Check whether the cable connecting the load and power supply is short-circuited and whether it is in good contact.
- c. Check whether the load works normally.

- d. Check whether the voltage setting value of this scale is proper; if it is too low, increase the voltage setting value properly.
- e. If the problem still persists, please contact RIGOL.

4. The USB storage device cannot be recognized.

- a. Check whether the USB storage device can work normally.
- b. Make sure that a flash memory USB storage device of FAT32 format is used, as this instrument does not support hard disk USB storage device.
- c. Restart the instrument and insert the USB storage device to check.
- d. If the USB storage device still cannot work normally, please contact RIGOL.

17 Specifications

All the specifications^[1] can only be guaranteed when the instrument is operated continuously for more than 30 minutes under the specified operation temperature.

Number of Channels

Model	Number of Channels
DP2031	3

DC Output (0°C~40°C)

DC output (0°C~40°C)			
		Voltage/Current	OVP/OCP
Range1	CH1	0 to 32 V/0 to 3 A	1 mV to 35.2 V/1 mA to 3.3 A
	CH2	0 to 32 V/0 to 3 A	1 mV to 35.2 V/1 mA to 3.3 A
	CH3	0 to 6 V/0 to 5 A	1 mV to 6.6 V/1 mA to 5.5 A
Range2 (Optional)	CH1	0 to 32 V/0 to 2 A	1 mV to 35.2 V/1 mA to 2.2 A
	CH2	0 to 32 V/0 to 2 A	1 mV to 35.2 V/1 mA to 2.2 A
	CH3	0 to 6 V/0 to 10 A	1 mV to 6.6 V/1 mA to 11 A

Internal Series/Parallel Mode

Internal series/parallel mode	
Series mode voltage	64 V
Parallel mode current	6 A

Load Regulation Rate

Load regulation rate, ± (% of output + offset)	
Voltage	<0.01%+2 mV
Current	<0.01%+250 μA

Line Regulation Rate

Line regulation rate, ± (% of output + offset)	
Voltage	<0.01%+2 mV

Line regulation rate, \pm (% of output + offset)

Current	<0.01%+250 μ A
---------	--------------------

Output Ripple and Noise**Output ripple and noise (20 Hz to 20 MHz)**

Normal mode voltage	<350 μ V _{rms} /2 mV _{pp}
---------------------	---

Normal mode current	<2 mA _{rms}
---------------------	----------------------

Accuracy 12 months (25°C \pm 5°C)**Accuracy 12 months (25°C \pm 5°C)^[2], \pm (% of output + offset)**

	Programming		Readback		Low range current ^[3]
	Voltage	Current	Voltage	Current	
CH1	0.03%+8 mV	0.15%+5 mA	0.05%+8 mV	0.15%+5 mA	0.25%+28 μ A
CH2	0.03%+8 mV	0.15%+5 mA	0.05%+8 mV	0.15%+5 mA	0.25%+28 μ A
CH3	0.04%+4 mV	0.15%+10 mA	0.08%+3 mV	0.15%+10 mA	Not available

Resolution**Resolution**

	Programming		Readback			Display		
	Voltage	Current	Voltage	Current	Low range current ^[3]	Voltage	Current	Low range current ^[3]
CH1	1 mV	0.1 mA	0.1 mV	0.1 mA	1 μ A	1 mV	0.1 mA	1 μ A
CH2	1 mV	0.1 mA	0.1 mV	0.1 mA	1 μ A	1 mV	0.1 mA	1 μ A
CH3	1 mV	1 mA	0.1 mV	0.1 mA	Not available	1 mV	0.1 mA	Not available

Transient Response Time**Transient response time**

Less than 50 μ s of time to recover to within the \pm 15 mV settling band following a load change from 50% to 100% or from 100% to 50% of full load.

Command Processing Time**Command processing time^[4]**

<10 ms

OVP/OCP Accuracy**OVP/OCP accuracy, ± (% of output + offset)**

OVP accuracy, ± (% of output + offset)	0.2%+20 mV
--	------------

OCP accuracy, ± (% of output + offset)	0.5%+20 mA
--	------------

Voltage Programming Response Time (Within 99% of the Total Variation Range)**Voltage programming response time (within 99% of the total variation range)**

Channel	Full Load (Up)	No Load (Up)	Full Load (Down)	No Load (Down)
CH1	<50 ms	<30 ms	<50 ms	<400 ms
CH2	<50 ms	<30 ms	<50 ms	<400 ms
CH3	<15 ms	<14 ms	<20 ms	<100 ms

Temperature Coefficient Per °C**Temperature coefficient per °C, ± (% of output + offset)**

Channel	Voltage	Current
CH1	0.01%+4 mV	0.01%+2 mA
CH2	0.01%+4 mV	0.01%+2 mA
CH3	0.01%+4 mV	0.01%+3 mA

Mechanical Characteristics**Mechanical characteristics**

Dimension	239 mm (W) x 157 mm (H) x 419 mm (D)
-----------	--------------------------------------

Weight	9.95 kg
--------	---------

Rack mount kit	Three rack-units (3U), 1/2-rack form factor
----------------	---

Power Source**Power source**

	100 V _{ac} ±10%
	120 V _{ac} ±10%
AC input (50 Hz to 60 Hz)	220 V _{ac} ±10%
	230 V _{ac} ±10% (max. 250 V _{ac})
Maximum input power	650 VA

Interface**Interface**

USB DEVICE	1
USB HOST	2 (1 for front panel and 1 for rear panel)
LAN	1
RS232	1
Digital IO	1 (optional for DP932U; not available for DP932E)
GPIB	1 (optional)
Rear Output Terminals	3

Environmental Conditions**Environmental conditions**

Cooling Method	Fan cooling
Operating Temperature	0°C to +40°C
Storage Temperature	-40°C to +60°C
Humidity	5% to 80% relative humidity
Altitude	Below 1500 meters
IP Rating	IP20
Pollution Degree	PD2

Environmental conditions

Overvoltage Categories

OVC II

Operating Environment

For indoor use only and non-operating in humid environment.

Warranty and Calibration Interval

Warranty and calibration interval

Warranty

3 years (excluding the accessories)

Recommended
calibration interval

Every 12 months

Note[1]:

- Unless otherwise stated, the specifications are applicable to all the channels of the specified model.
- All parameters are measured at rear output terminals.
- Not applicable in series/parallel connection mode.

Note[2]: The accuracy parameters are acquired via calibration under 25°C after 1-hour warm-up.

Note[3]: The low range current mode is applicable to measurement of current lower than 10 mA.

Note[4]: the time required for the output to change accordingly after receiving the APPLy and SOURce commands.

18 Appendix

18.1 Appendix A: Accessories and Options

Order Information	Order No.
Base Unit	
Programmable linear DC power supply, triple-output, high precision	DP2031
Standard Shipped Accessory	
USB cable	CB-USBA-USBB-FF-150
One fuse	— —
Power cord (based on destination country)	— —
Two pairs of connecting wires (10 A)	10A-Testing-Cable
Optional Accessory	
GPIB user installable interface module	DP2000-GPIB
CH3 10 A high range mode	DP2000-10A
7.5 kSa/s high-speed sampling option	DP2000-HADC
DP2000 Rack Mount Kit (for a single instrument)	RM-1-DP800
DP2000 Rack Mount Kit (for two instruments side-by-side)	RM-2-DP800

NOTE

For purchasing models, accessories, and options, please contact local RIGOL office.

18.2 Appendix B: Warranty

RIGOL TECHNOLOGIES CO., LTD. (hereinafter referred to as RIGOL) warrants that the product mainframe and product accessories will be free from defects in materials and workmanship within the warranty period. If a product proves defective within the warranty period, RIGOL guarantees free replacement or repair for the defective product.

To get repair service, please contact your nearest RIGOL sales or service office.

There is no other warranty, expressed or implied, except such as is expressly set forth herein or other applicable warranty card. There is no implied warranty of merchantability or fitness for a particular purpose. Under no circumstances shall RIGOL be liable for any consequential, indirect, ensuing, or special damages for any breach of warranty in any case.

HEADQUARTER

RIGOL TECHNOLOGIES CO., LTD.
No.8 Keling Road, New District, Suzhou,
JiangSu, P.R.China
Tel: +86-400620002
Email: info@rigol.com

EUROPE

RIGOL TECHNOLOGIES EU GmbH
Carl-Benz-Str.11
82205 Gilching
Germany
Tel: +49(0)8105-27292-0
Email: info-europe@rigol.com

NORTH AMERICA

RIGOL TECHNOLOGIES, USA INC.
10220 SW Nimbus Ave.
Suite K-7
Portland, OR 97223
Tel: +1-877-4-**RIGOL**-1
Fax: +1-877-4-**RIGOL**-1
Email: info@rigol.com

JAPAN

RIGOL JAPAN CO., LTD.
501, LATORRETTA, 2-37-1,
Numabukuro,
Nakano-Ku, Tokyo, Japan
Tel: +81-3-6262-8932
Fax: +81-3-6262-8933
Email: info-japan@rigol.com

RIGOL® is the trademark of **RIGOL TECHNOLOGIES CO., LTD.** Product information in this document subject to update without notice. For the latest information about **RIGOL's** products, applications and services, please contact local **RIGOL** channel partners or access **RIGOL** official website: www.rigol.com